

# LiGrip 01 Lite

Lightweight 3D Laser Scanner

## Quick Start Manual

Version A.00

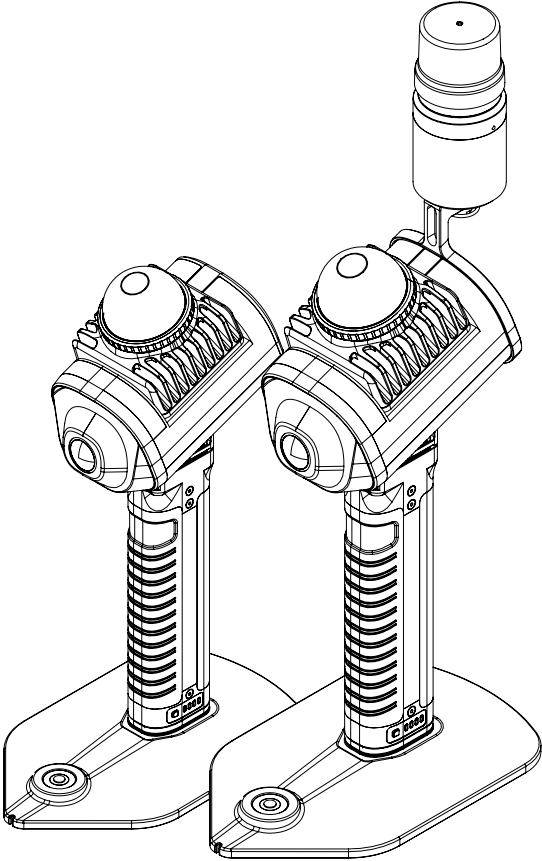



# Contents

I. Product Structure	1
II. Device Installation and Removal	2
III. Power On	5
IV. Registration and Activation	6
V. Data Collection Status Light Indicators and Interpretations	9
VI. RTK Light Status Indicators and Interpretations	9
VII. Connecting the Device Using the APP	9
VIII . Choosing the Initialization Location	10
IX. Starting Data Collection	11
X. Data Transfer	18
XI. Device Shutdown	20
XII. SLAM Process	21
XIII. Batch Processing	28
XIV .Data Export	28

# I. Product Structure

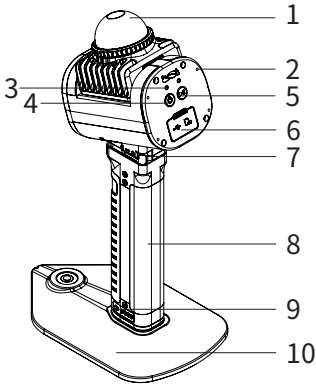

1. LiDAR sensor
2. RTK Module Mounting Holes (4 in total)
3. Indicator Lights (Left: Power indicator light , Right: Data acquisition status indicator light)
4. Power Button
5. Data Collection Button
6. Type-C Port and TF Card Slot
7. Locking Handle
8. Smart Battery
9. Battery Level Display Button
10. Base Stand

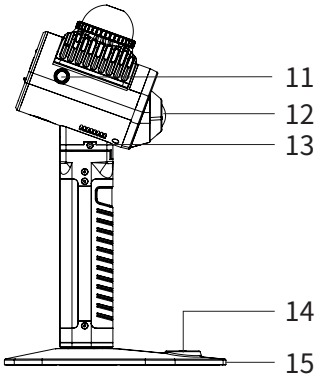

11. RTK Port (Device End)
12. Camera
13. Anti-Detachment Button
14. Level Bubble
15. GCP Pointer

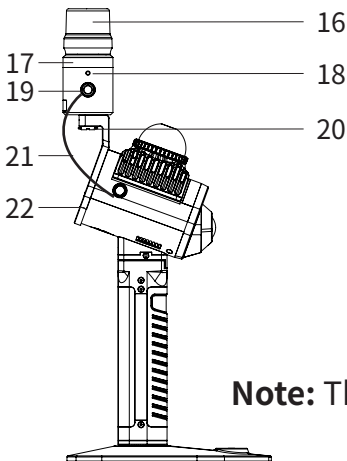

16. GNSS Antenna
17. GNSS Board and 4G Module
18. RTK Status Indicator Light
19. RTK Port (RTK End)
20. RTK Fixed Knob
21. LEMO Cable
22. RTK Bracket

**Note:** The RTK Module is an optional accessory.

## II. Device Installation and Removal

### 2.1 Battery Installation and Removal

#### 2.1.1 Installation



Align the battery with the bottom of the device, gently insert it until you hear a click, then press down the locking handle.

#### 2.1.2 Removal

To remove the device, flip open the locking handle, press the anti-detachment button, and pull the battery out towards you.



## 2.2 Base Stand Installation and Removal

### 2.2.1 Installation



Align the mounting holes of the base stand with the holes at the bottom of the battery, then tighten the base stand screws.

### 2.2.2 Removal

Unscrew the base stand screws and pull out the base stand.

## 2.3 RTK Module Installation and Removal

### 2.3.1 Installation

(1) Preparing the RTK Bracket, M2.5\*4 Screws, Screwdriver, RTK Module, SIM card pin, LEMO Cable, and Nano-SIM Card (from left to right).



(2) Use SIM card pin tool to remove the SIM card, and properly install the SIM card into its holder. Then, insert the SIM card holder into the slot.



Note: Align the dot on the card holder with the origin point at the bottom of the RTK.



(3) The RTK bracket is mounted on the back of the device. Use the screwdriver to tighten the screws.



(4) Align the bottom of the RTK module with the limiting holes at the top of the RTK bracket and tighten the RTK fixing knob.



(5) Connect the RTK module to the device's main unit with the LEMO cable.



### 2.3.2 Removal

For general operations, only the RTK module needs to be removed; the mounting bracket can remain attached.

To remove the RTK module, first disconnect the LEMO cable from the RTK module. Then, loosen the RTK fixing knob and remove the RTK module.

To remove the mounting bracket, use a screwdriver to dismantle it.

## III. Power On

Press and hold the power button until the button flashes, then release. The device powers on automatically. When the power indicator and the data collection status indicator lights are ever bright green, it indicates the startup is complete.



Press and hold the power button



Green light flashes



Both remain ever bright



## IV. Registration and Activation

Device registration, project management, setting the coordinate system, RTK configuration, and real-time point cloud viewing must be done through the GreenValley APP.

Download link:<https://licloud.greenvalleyintl.com/api/v1/software/147/package>

Or, Scan the QR code to download the app(Left:iOS,Right:Android)



### 4.1 Registration and Activation

Use your email to register for activation, and you can open the app's user guide for the specific process.

### 4.2 Activation

(1) Connect the device WIFI

After the device is turned on, turn on the cell phone WIFI, search for the corresponding WIFI of the device and connect it.



Device WiFi: LiGrip O1 Lite-\*\*\*\* (last four digits of SN) Password: greenvalley

(2) Open the APP and connect to device

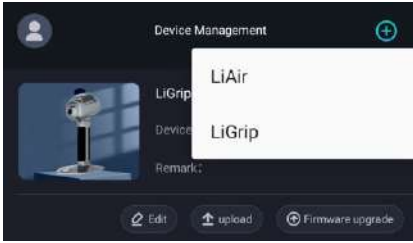

(3) Activate the device

After connecting the device, APP pops up the interface that needs to be activated. According to the APP prompts, complete the switching of the network and finally complete the activation.

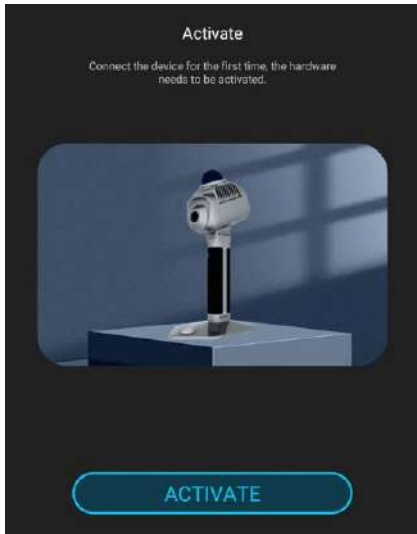

activation screen

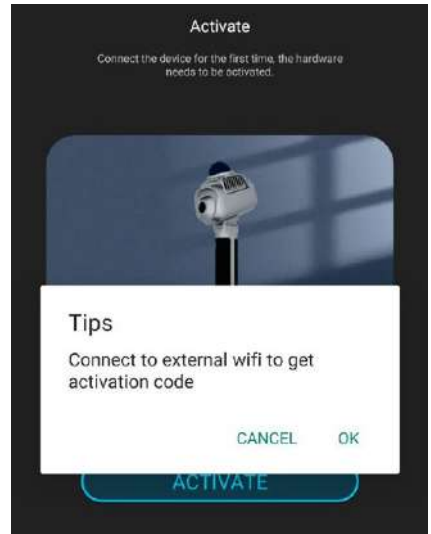

Prompt to switch WIFI, click OK



Disconnect the device WIFI

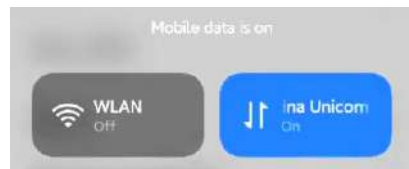

Connect to 4G network and return to APP interface

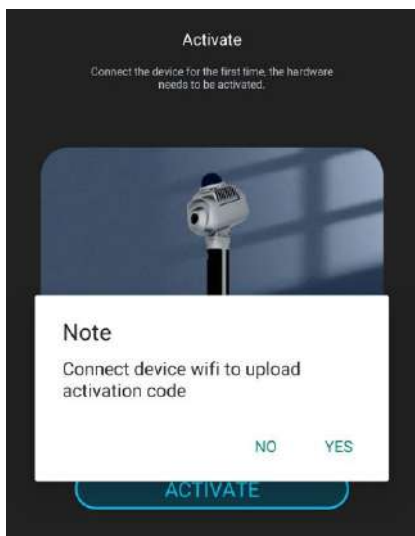

Upload activation code, OK

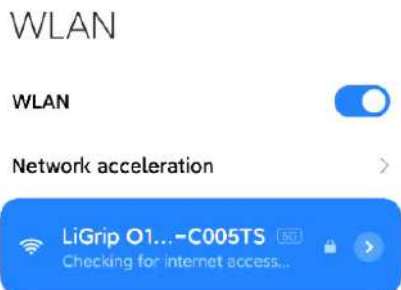

Connect the device WIFI

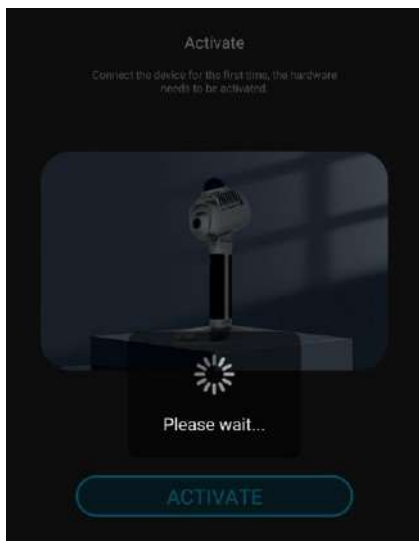

activating



After the APP prompts for successful activation, connect to device, and finally restart the device

## V. Data Collection Status Light Indicators and Interpretations



- **Fast Flash:** The device is initializing, collecting Ground Control Points (GCPs), or saving data.
- **Slow Flash:** The device is collecting data
- **Ever Bright:** The device is ready.

## VI. RTK Light Status Indicators and Interpretations



- **Fast Flash:** The device is initializing or searching for satellites.
- **Slow Flash:** Unfixed solution
- **Ever Bright:** Fixed solution
- **Red:** Configuration in progress

## VII. Connecting the Device Using the APP



If APP operation is not required, this step can be skipped.

Open the GreenValley APP, and connect your mobile device (phone/tablet) to the O1 Lite WiFi. Select the '+' sign at the top right corner of the APP, click on "LiGrip", then click on the name of the device you have purchased. The APP will indicate a successful connection.



Device WiFi: LiGrip O1 Lite-\*\*\*\* (last four digits of SN) Password: greenvally

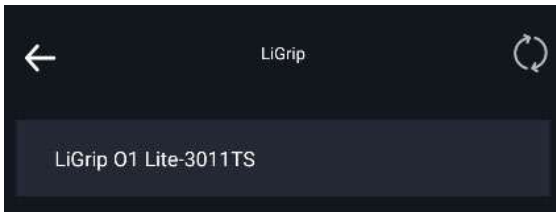

## VIII. Choosing the Initialization Location

The so-called initialization location refers to a location that meets the prerequisites for the device to run the initialization program correctly and achieve optimal results.

### 8.1 Operating with the RTK Module

- (1) Place the device on stable ground or a platform.
- (2) Ensure a good satellite search environment with a recommended satellite count of  $\geq 20$ ; for RTK positioning, a fixed solution (RTK light ever bright) is required, with both horizontal and vertical standard deviations less than 0.05.
- (3) Avoid areas with strong electromagnetic interference.
- (4) Do not initialize in areas with high pedestrian or vehicular traffic.
- (5) Avoid initializing in empty areas, such as squares or sports fields.

## 8.2 Operating without the RTK Module

- (1) Place the device on stable ground or a platform. For indoor operations, place the device on the floor.
- (2) Avoid initializing in doorways or areas with high pedestrian/vehicle traffic.
- (3) Avoid initializing in empty areas, such as squares or sports fields.
- (4) When initializing in a mine, position the device in the direction of the mine's progression.

## IX. Starting Data Collection

The O1 Lite supports two data collection modes: button-based collection and smartphone APP-based collection. Button collection allows you to operate without a smartphone, while APP collection offers interactive operations such as real-time point cloud display, RTK configuration, and data deletion. Choose the collection method that best suits your needs.

### 9.1 RTK Configuration



Any GNSS configuration should be conducted outdoors with satellite visibility.

Tap the settings button in the top right corner of the APP, select RTK link, and then configure it using the RTK configuration parameters provided by your CORS service provider. Upon successful configuration, the system will indicate success. Wait for the APP to display a fixed solution, or move O1 Lite to find a location that can be fixed.



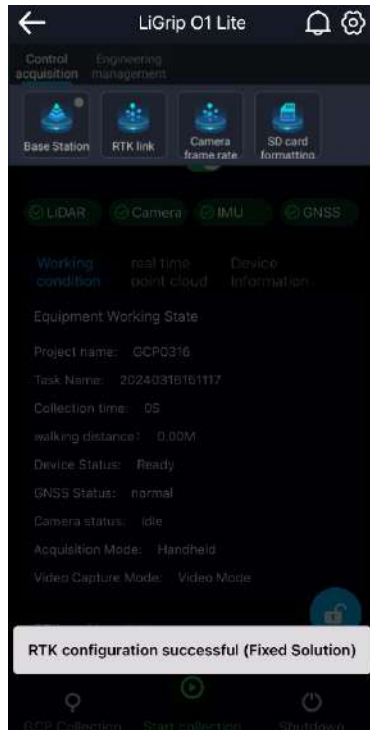
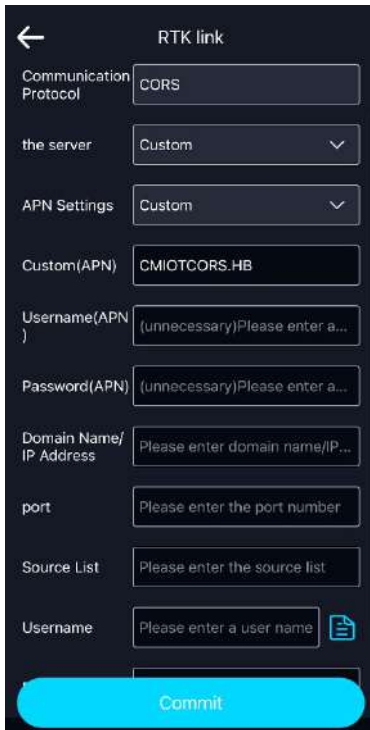

Once RTK configuration is successful, it is not necessary to reconfigure upon next startup; the system will automatically use the previous configuration parameters for automatic configuration.

## 9.2 Collecting Data Using the APP

### 9.2.1 Operating with RTK

#### (1) New Acquisition

There are two methods to create a new acquisition.

Tap "Start Collection," choose an existing project, or create a new project.

If opting to create a new project, enter the project name, collection location, set the coordinate system, and other parameters. Then, select the newly created project to start a new task.

If choosing an existing project, you can use a previously created project to set up a new task.



Any GNSS configuration should be conducted outdoors with satellite visibility.

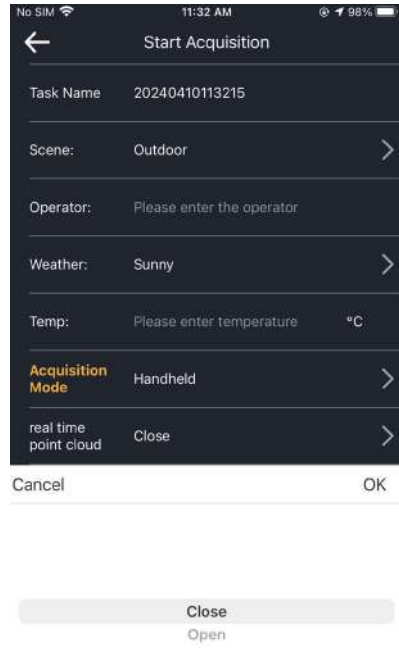
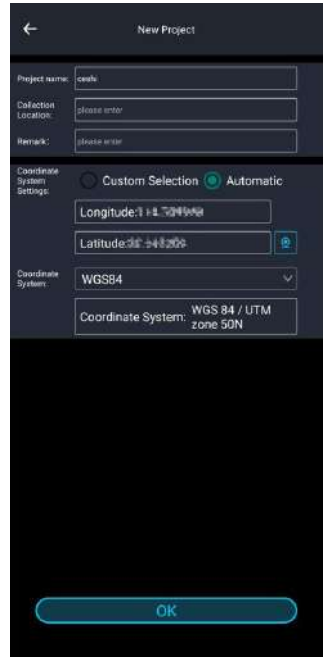



Task details such as task name, scene, weather, temperature, and photos from the field can be entered.



All options are optional except for the task name;

Note:

1. You can choose whether to save real-time Pointcloud in the task interface. By default, it is closed and real-time results will not be saved
2. Control the acquisition through the button and the real-time results will not be saved

## (2) Initialization

After tapping "Start Collection," the device enters the initialization phase, with vocal prompts from the APP and the data collection status light flashing fast.

Wait for the device status on the APP to change from "Acquisition preparation" to "Collecting." When the APP vocal prompt indicates "Device is collecting" (status light flashes slowly), initialization is complete.



It is critical to keep the device still during the initialization process.

## (3) Performing a 'Figure of Eight' and Starting Data Collection

After initialization, you can slowly pick up the device and prepare to perform a 'figure of eight' (consisting of two circles with a radius of no less than 2 meters each). Once the 'figure of eight' is completed, you can begin data collection.

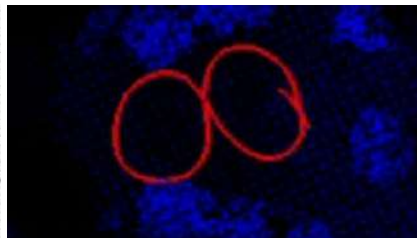
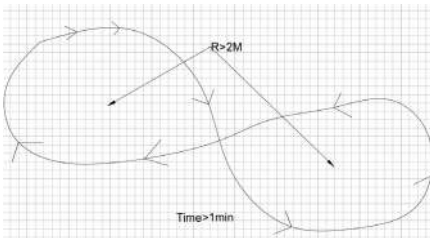

During the collection process, pay attention to the RTK fixed solution status. If a fixed solution cannot be achieved, please wait for the fixed solution or move to another location where it can be fixed.

By clicking on the real-time point cloud, you can observe the condition of the real-time point cloud, trajectory, RTK status, device status, etc.

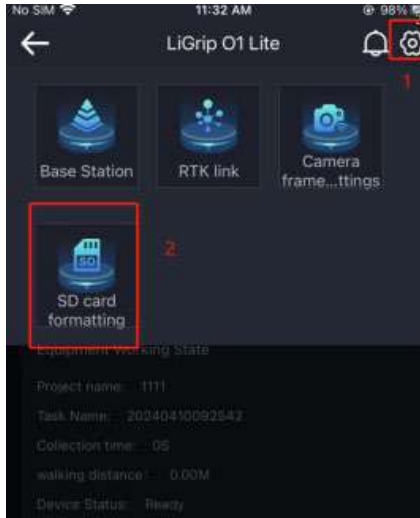
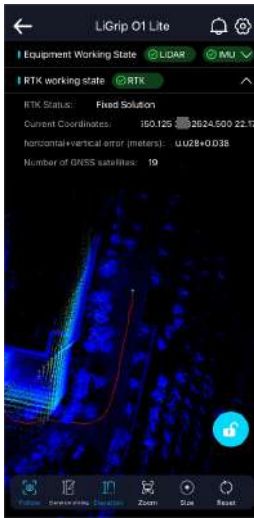

**Note:** During the collection process, if the APP interface prompts "The current SD card speed is too low. Do you want to stop collecting?," it is recommended to stop collecting, backup the data, and format the SD card before proceeding.

#### (4) Ending Data Collection



After data collection has ended, perform a 'figure of eight' again, following the same requirements as at the start. Place the device on the ground or on a platform. Press the stop data collection button (the status light will flash fast), and wait for the progress bar to complete before proceeding to the next collection.



After pressing the stop data collection button, as long as a progress bar appears, you can move the device and wait for the data to be completely saved.

## 9.2.2 Operation with PPK

Absolute positioning calculations are performed using PPK (you need to set up your own base station.), thus, unlike operations with RTK, there is no need to monitor for a real-time fixed solution during collection.

All other steps are identical to those during operations with RTK.

## 9.2.3 Operation without a RTK Module

When operating without a RTK module, if absolute coordinate results are required, then the GCP base stand will be required. If absolute coordinate results are not required, please follow the steps 1->2->3->5.

### (1) New Acquisition

Identical to operations with RTK.

### (2) Initialization

Identical to operations with RTK.

### (3) Start Collecting

Apart from not needing to focus on GNSS, the remaining procedures are identical to those when operating with RTK.

Given the absence of GNSS, to reduce SLAM's accumulated error, it's crucial to execute a close-loop operation, following the route planning principles outlined below.

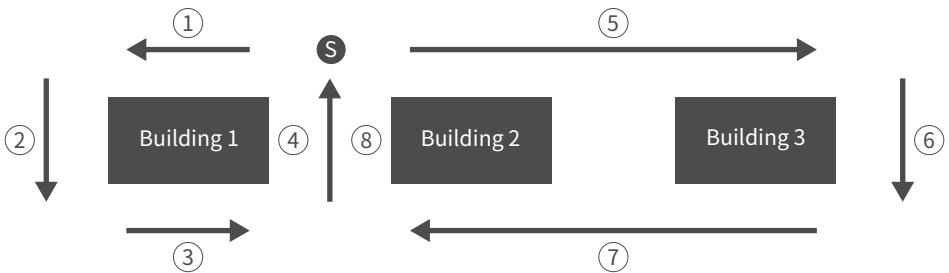

As depicted, you should start from point S and then complete a close-loop maneuver (sequentially numbered in the diagram), ultimately returning to the original point (repeating the path by 5–10 meters).

### (4) Ground Control Point (GCP) Collection

For scenarios where a close-loop is unfeasible or absolute coordinates are required, it's necessary to employ GCP collection for the integration of coordinate positions or the elimination of accumulated errors.

Slowly squat down, aiming the GCP pointer at the desired location



Note: Do not gather people around when collecting GCPs.



Tap the GCP collection button on the APP's screen (you can rename the GCP; by default, it's LiGrip \*, where \* is a number that automatically increments with each collection). At this moment, the device's status light will flash fast.



Note: Please remain still during GCP collection

The collection is completed when the APP signals the end of the process, or the status light starts flashing slowly.

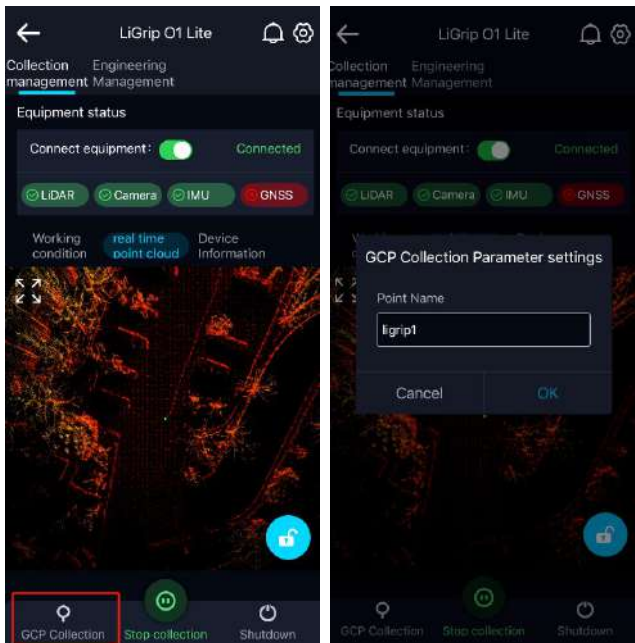

## (5) Ending Data Collection

The procedure for ending data collection is consistent with operations involving RTK.

## 9.3 Button-Based Data Collection

When opting for button-based data collection, without the APP's prompts or status displays, it becomes essential to closely observe the device's status lights (as described in sections V and VI) and strictly adhere to the initialization location selection guidelines set forth in section VIII .

### 9.3.1 Operating with RTK

#### (1) New Acquisition

Long-press the data collection button until it flashes fast, then release to easily create a new project;



projects are named according to the date and time by default.

#### (2) Initialization

Identical to operations involving RTK.

#### (3) Starting Data Collection

Similar to operations with RTK, it is necessary to monitor changes in the RTK light.

#### (4) Ending Data Collection

Long-press the data collection button until it flashes fast, then release when the status light remains ever bright.

### 9.3.2 Operation with PPK

Nearly identical to 9.3.1 operations, but there's no need to pay attention to the RTK light status.

### 9.3.3 Operating without a RTK Module

Different from 9.2.3 mainly in terms of GCP collection.

For GCP collection, press (not long-press) the data collection button, causing the device's status light to flash fast.

The collection is complete when the status light starts flashing slowly.

## X. Data Transfer

The project folder contains multiple collected task folders and a project.json file; task folders include an IMG folder (storing .bin camera files), RealTimeResult folder, bag/log/rtk files, mission.json, gvlog log files, and more.

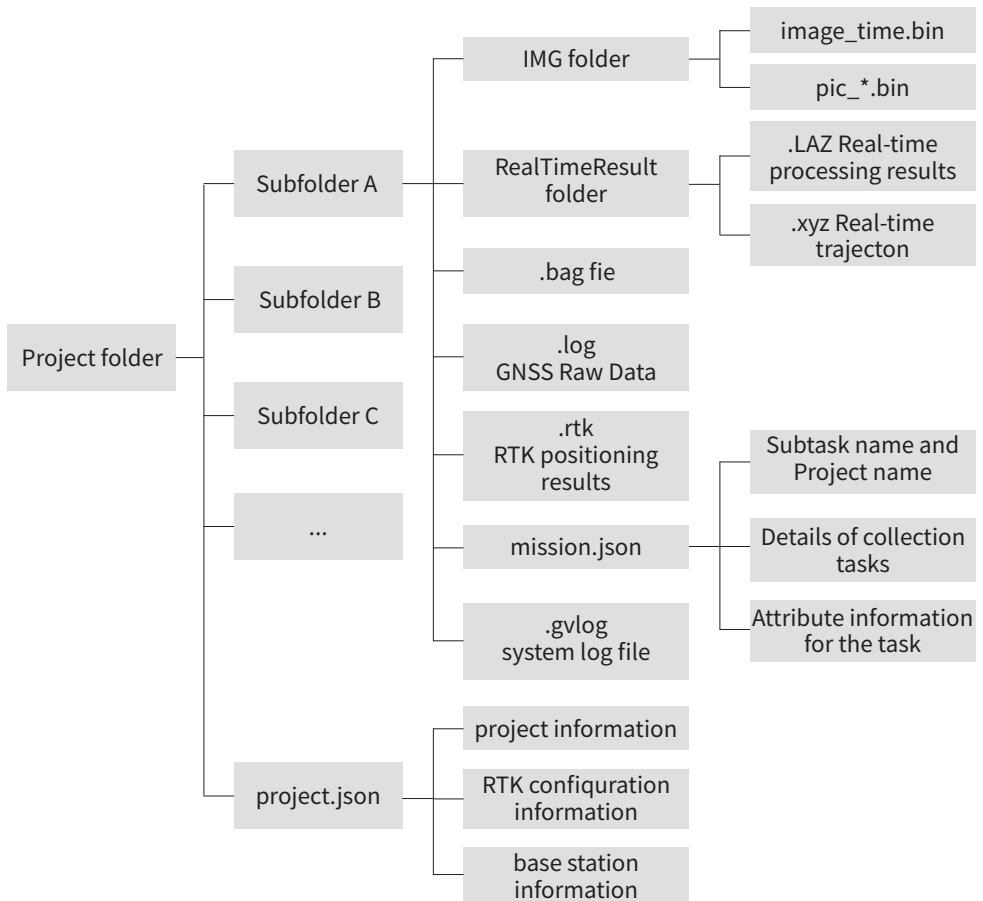

## 10.1 Copying via TF Storage Card (Recommended)

Eject the TF card and insert it into a card reader, then use a computer to copy the project or task files stored on the TF card (including bag, bin, log, rtk files, etc.).

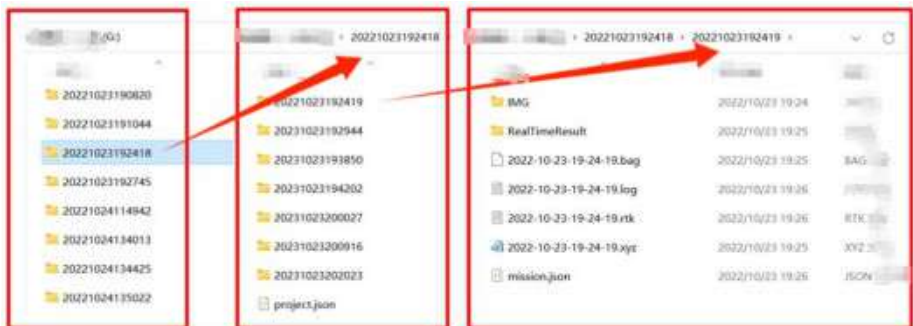

## 10.2 Copying via Type-C

Connect a USB drive or portable hard disk to the device's Type-C port. Use the GreenValley APP to connect to WiFi, select one or more projects from the project list, and copy the selected project(s) to the USB drive. Wait until "Project Copy Successful" is displayed before removing the drive.

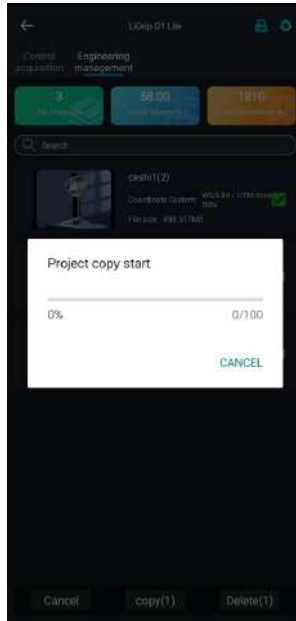

If you want to safely eject the removable storage device, click on the USB icon and wait for the system to prompt for success.

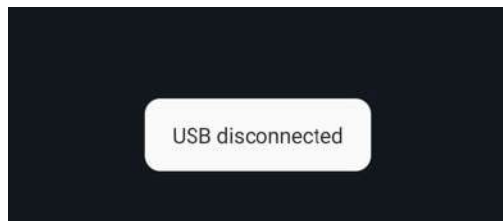

## XI. Device Shutdown

The device can be shut down in two ways:

- Use the APP to initiate shutdown. Wait for the indicator light to turn off automatically, indicating the device has successfully shut down.
- Long-press the power button until the indicator light flashes fast, then turns off automatically, indicating the device has successfully shut down.

## XII. SLAM Process

Use the latest version of LiDAR 360 MLS, version 7.2 or above, for SLAM processing. Refer to the LiDAR 360 MLS software manual for hardware requirements.

### 12.1 Processing Data with RTK

1. Click on the MLS interface to create a new SLAM project, or go to File -New -Create New SLAM Project".

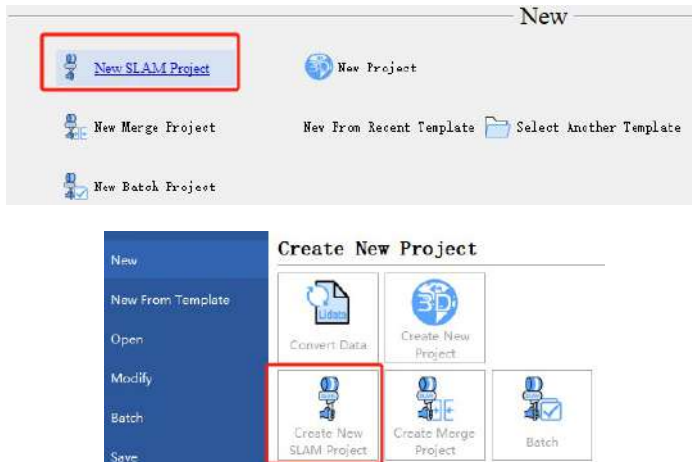

2. Set up the laser file and IMG path (optional), leave the camera type as default, and proceed to the next step.



3. Configure GNSS data, check "Process GNSS", select "External Input", choose the RTK file, and proceed to the next step.



← New Project Wizard

### Configure GNSS Data

Please set GNSS Data, which can provide information for the absolute georeference. This page could be skipped if GNSS is not available, then the results will be calculated in a local coordinate system.

Process GNSS

GNSS Process Mode

External Input     Differential GNSS     Internal

External

POS File: E:/DATA/01-LITE/20240316/RTK/LiGripData/RTK/20240316154545/2024-03-16-15-45-56.rtk

Next    Cancel

4. Do not select a coordinate system; proceed directly to the next step.

← New Project Wizard

### Configure GNSS Data

Please set GNSS Data, which can provide information for the absolute georeference. This page could be skipped if GNSS is not available, then the results will be calculated in a local coordinate system.

Process GNSS

GNSS Process Mode

External Input     Differential GNSS     Internal

External

POS File: E:/DATA/01-LITE/20240316/RTK/LiGripData/RTK/20240316154545/2024-03-16-15-45-56.rtk

Next    Cancel

5. Configure the project folder and project file name, leaving them as default, and click finish.

← New Project Wizard

### Configure Project Location

Please set the path where the project will be saved. A directory for the project will be created.

Location: E:/DATA/01-LITE/20240316/RTK/LiGripData/RTK/20240316154545

Name: 2024-03-16-15-45-56

Finish    Cancel

6. After entering the main interface, click the start button  .

Note: If there is a need to modify settings, you can do so within the project settings. For detailed instructions, please refer to the LiDAR 360 MLS software operation manual.

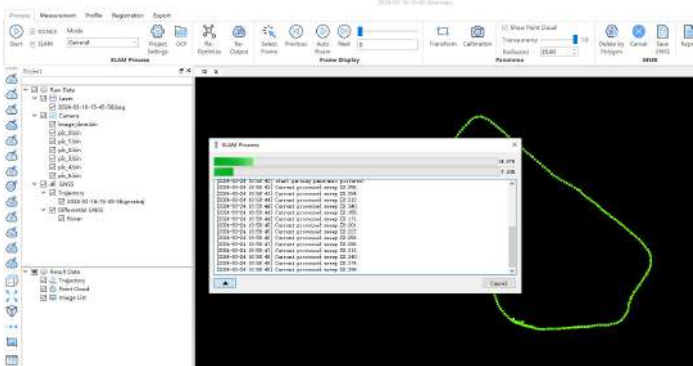

Wait for the program to complete running to obtain the final point cloud data results.

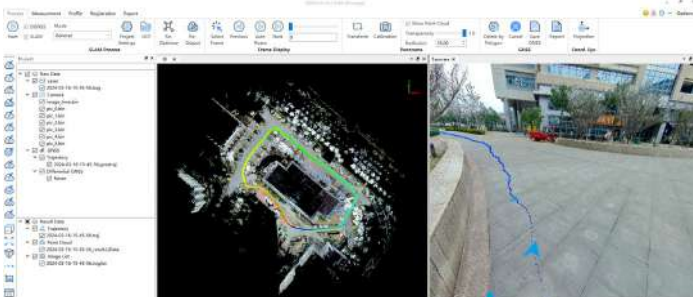

## 12.2 Processing PPK Data

Before processing PPK data, it's necessary to prepare base station data (usually in RINEX format).

1. The setup for LiDAR and image data is the same as sections 12.1 (1) and (2).
2. To configure GNSS data, select "Process GNSS" and choose "Differential GNSS", select the rover GNSS log file, select the base station RINEX file, enter the base station coordinates, and proceed to the next step.

← New Project Wizard

### Configure GNSS Data

Please set GNSS Data, which can provide information for the absolute georeference. This page can be skipped if GNSS is not available, then the results will be calculated in a local coordinate system.

Process GNSS

GNSS Process Mode  
 External Input       Differential GNSS       Internal

Rover Data  
Log File:  ...

Base Station Data  
 LiTracer       RTK/RTK/RTK       NovAtel       EIMEX

Baseline  
 IBS/PPS (General Mode)       Multi Base Station Mode

Base (ORS):  ...

Base (BAV):  ...

Base (BAW)-Optional:  ...

Base (CBW)-Optional:  ...

Location Mode:  From Header       Manual       Select from Favorites

Unit:  Decimal Degree (dd. dddd dddd)       DD MM SSSS

Latitude: North  ...

Longitude: East  ...

WGS84 Ellipsoidal Height(s):  ...

Antenna Height(s):  ...

Projection Transformation

(3) For coordinate system configuration, select the target coordinate system. You can quickly find a coordinate system by using the "Filter" to input keywords, then proceed to the next step.

← New Project Wizard

### Configure Coordinate System

The coordinate system is used to project GNSS coordinates from (Longitude, Latitude, height) to (U, V, H). This page is optional. If the target coordinate system is NOT set, the coordinates will be projected to WGS84 UTM system by default.

Target Coordinate System

No Setup Parameter

Seven Parameter Setting:

Target Coordinate System Name:  ...

Filter:  ...

Horizontal:  Vertical:

Horizontal Coordinate System:

Coordinate Reference System	Authority ID
Recent	
CRS32000 / 3-degree Gauss-Kruger CM 10BE	EPSG:4545
Projected Coordinate Systems	
Transverse Mercator	
NZGD2000 / Hawkes Bay 2000	EPSG:2108
GSK-2011 / GSK 3GK CM 10BE	EPSG:2136
Xian 1980 / 3-degree Gauss-Kruger CM 10BE	EPSG:2381
Beijing 1954 / 3-degree Gauss-Kruger CM 10BE	EPSG:2453
Pulkovo 1942 / 3-degree Gauss-Kruger CM 110BE	EPSG:2812
Pulkovo 1905 / 3-degree Gauss-Kruger CM 10BE	EPSG:2738

Finally, configure the project save location and name.

(4) After entering the main interface, click the start button. The program will first run PPK, then proceed with the SLAM process.

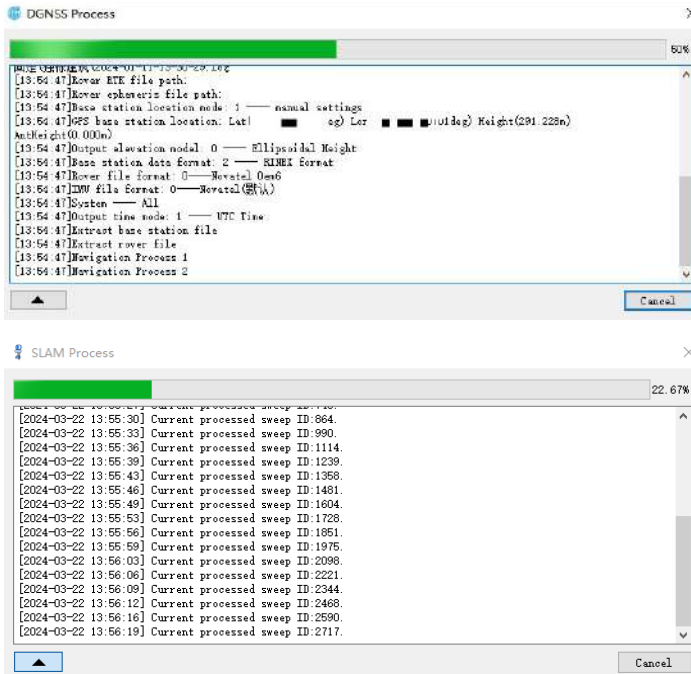

## 12.3 SLAM process with Relative Coordinates

This process is consistent with 12.1, except there is no need to configure GNSS data and the coordinate system. Simply start the process to obtain point cloud results in a relative coordinate system.

## 12.4 SLAM process with Control Points

### 1. Obtaining Point Clouds with Relative Coordinates

Identical to section 12.3.

To work with control points and endow the final point cloud with absolute coordinates, follow the steps below.

2. Click on "GCP"  on the interface, and in the point pairs registration interface, click on "Load Points" and select the geotag.txt file.

### Point Pairs Registration

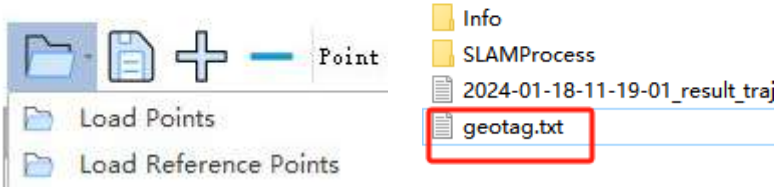

3. In the ASCII file dialog box, simply click "Apply".

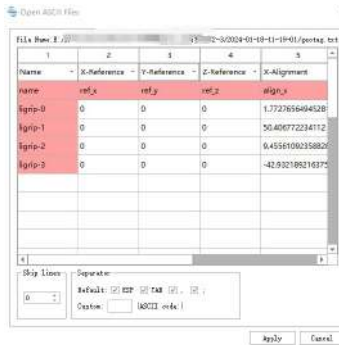

This will display the locations of the collected points on the interface.

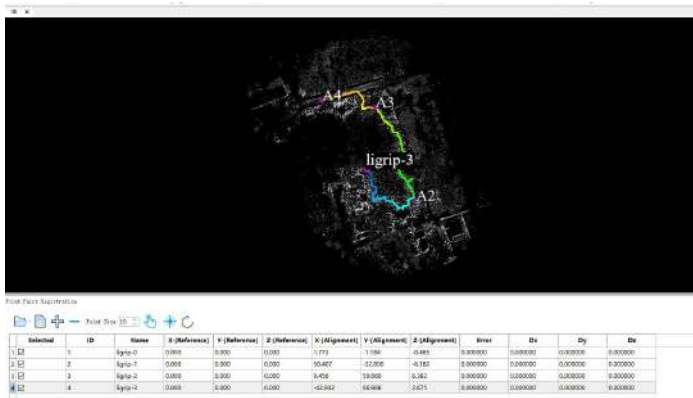

4. In the point pairs registration interface, click on "Load Reference Points".

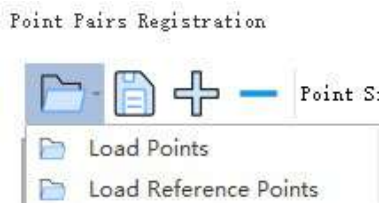

Set up the columns corresponding to X and Y, noting that X corresponds to easting and Y to northing. Click "Apply".



5. Click on "Apply GCP Transformation."

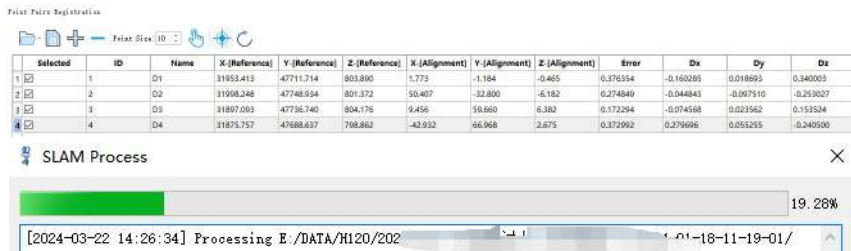

The final point cloud result will now align with the coordinates of the control points.

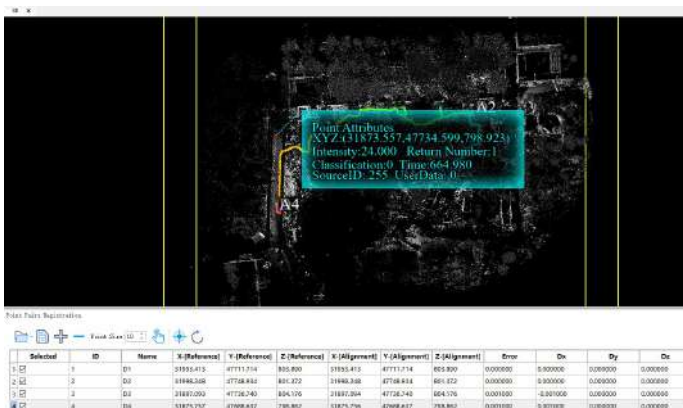

6.If the GCP conversion is not satisfactory, or if the control points have been entered incorrectly, you can click the restore button  to point the cloud to its original state

### XIII. Batch Processing



From the MLS main interface, click on "Batch Processing," or go to "File" -> "New" -> "Batch Processing" .

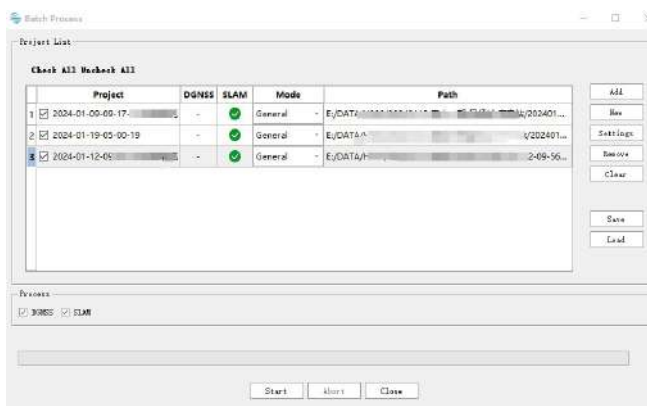

Batch processing is straightforward; for specific instructions, refer to the LiDAR 360 MLS software operation manual.



### XIV.Data Export

You can export data in LAS format, as well as Orbit and Geo-Plus formats. Additionally, you can write GPS positions (latitude and longitude) into panoramic images  or conduct accuracy checks on the point cloud  .

For data export operations, refer to the LiDAR 360 MLS software operation manual.



If you have any questions or suggestions about the manual, please contact us through the following methods:

E-mail: [info@greenvalleyintl.com](mailto:info@greenvalleyintl.com)

Address: 729 Heinz Avenue, Space 9, Berkeley, California 94710, U.S.A

Map The World In 3D  
[www.greenvalleyintl.com](http://www.greenvalleyintl.com)