



# LS500W1

## User Manual

V1.0.3 2024.10



## **Safety Instruction**

Before using the product, please read and follow the instructions of this manual carefully, and refer to relevant national and international safety regulations.

### **ΔAttention**

Please do not disassemble or modify the lidar privately. If you need special instructions, please consult our technical support staff.

### **ΔLaser Safety Level**

The laser safety of this product meets the following standards:

- IEC 60825-1:2014
- 21 CFR 1040.10 and 1040.11 standards, except for the deviations (IEC 60825-1, third edition) stated in the Laser Notice No. 56 issued on May 8, 2019. Please do not look directly at the transmitting laser through magnifying devices (such as microscope, head-mounted magnifying glass, or other forms of magnifying glasses).

### **Eye Safety**

The product design complies with Class 1 human eye safety standards. However, to maximize self-protection, please avoid looking directly at running products.



### **ΔSafety Warning**

In any case, if the product is suspected to have malfunctioned or been damaged, please stop using it immediately to avoid injury or further product damage.

### **Housing**

The product contains high-speed rotating parts, please do not operate unless the housing is fastened. Do not use a product with damaged housing in case of irreparable losses. To avoid product performance degradation, please do not touch the photomask with your hands.

### **Operation**

This product is composed of metal and plastic, which contains precise circuit electronic components and optical devices. Improper operations such as high temperature, drop, puncture or squeeze may cause irreversible damage to the product.

### **Power Supply**

Please use the connecting cable and matching connectors provided with the lidar to supply power. Using cables or adapters that are damaged or do not meet

the power supply requirements, or supply power in a humid environment may cause abnormal operation, fire, personal injury, product damage, or other property loss.

### **Light Interference**

Some precise optical equipment may be interfered with by the laser emitted by this product, please pay attention when using it.

### **Vibration**

Please avoid product damage caused by strong vibration. If the product's mechanical shock and vibration performance parameters are needed, please contact us for technical support.

### **Radio Frequency Interference**

The design, manufacture and test of this product comply with relevant regulations on radiofrequency energy radiation, but the radiation from this product may still cause other electronic equipment to malfunction.

### **Deflagration and Other Air Conditions**

Do not use the product in any area with potentially explosive air, such as areas where the air contains high concentrations of flammable chemicals, vapours or particles (like fine grains, dust or metal powder). Do not expose the product to the environment of high-concentration industrial chemicals, including near evaporating liquefied gas (like helium), so as not to impair or damage the product function.

### **Maintenance**

Please do not disassemble the lidar without permission. Disassembly of the product may cause its waterproof performance to fail or personal injury.

# TABLE OF CONTENTS

<b>1. PRODUCT PROFILE</b> .....	<b>1</b>
1.1. OVERVIEW.....	1
1.2. MECHANISM.....	1
1.3. SPECIFICATIONS.....	1
1.4. DIMENSIONS .....	2
<b>2. ELECTRICAL INTERFACE .....</b>	<b>4</b>
2.1. POWER SUPPLY .....	4
2.2. WIRING DEFINITION.....	4
<b>3. GET READY.....</b>	<b>6</b>
3.1. LIDAR CONNECTION.....	6
3.2. SOFTWARE PREPARATION.....	6
3.2 SOFTWARE PREPARATION.....	6
<b>4. USAGE GUIDE.....</b>	<b>8</b>
4.1. OPERATION UNDER WINDOWS OS.....	8
4.1.1. Lidar Configuration .....	8
4.1.2. Upper Computer Platform .....	9
4.1.3. Point Cloud Data Parsing.....	9
4.2. ROS DRIVER OPERATION UNDER LINUX OS.....	10
4.2.1. Hardware Connection and Test.....	10
4.2.2. Software Operation Example .....	11
<b>5. COMMUNICATION PROTOCOL.....</b>	<b>13</b>
5.1. MSOP PROTOCOL .....	13
5.1.1. Format .....	13
5.1.2. Data Package Parameter Description.....	14
5.2. DIFOP PROTOCOL.....	16
5.3. UCWP PROTOCOL.....	17
5.3.1. Configuration Parameters and Status Description .....	19
5.3.2. Configuration Package Example.....	20
<b>6. TIME SYNCHRONIZATION .....</b>	<b>22</b>
6.1. GPS SYNCHRONIZATION .....	22
6.2. PTP/GPTP SYNCHRONIZATION .....	23
6.3. LIDAR INTERNAL TIMING.....	24
<b>7. ANGLE AND COORDINATE CALCULATION.....</b>	<b>26</b>
<b>APPENDIX A. MAINTENANCE .....</b>	<b>27</b>
<b>APPENDIX B. TROUBLESHOOTING.....</b>	<b>28</b>

# 1. Product Profile

## 1.1. Overview

The LS500W1 series hybrid solid-state LiDAR adopt Leishen Intelligent’s self-developed and self-produced 1550 (± 25) nm fibre laser as the light source, with a detection distance of 2~150 m. It can effectively identify different target attributes such as people, animals, vehicles, tyres and falling objects, and output information such as distance and 3D profile.

## 1.2. Mechanism

The lidar adopts the Time of Flight (ToF) method. The lidar starts timing ( $t_1$ ) when the laser pulses are sent out. And when the laser encounters the target object and the light returns to the sensor unit, the receiving end stops timing ( $t_2$ ).

$$\text{Distance} = \text{Speed of Light} * (t_2 - t_1) / 2$$

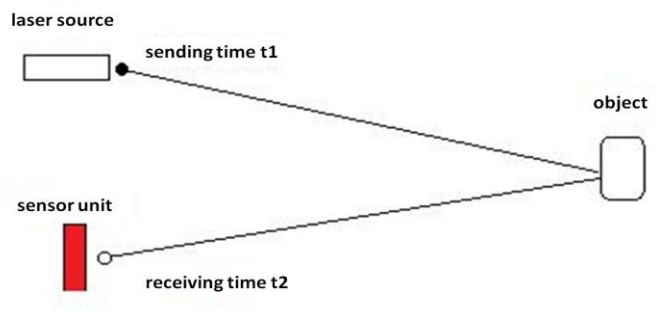

Figure 1.1 Time of Flight Ranging Mechanism

## 1.3. Specifications

Table 1.1 Specifications of LS500W1

Model	LS500W1
Detection Method	ToF
Wavelength	1550 (± 25) nm
Laser Class	Class 1 (eye-safe)
Detection Range	2 m ~60 m (@10% reflectivity) 150 m (Max.)
Range Accuracy	± 2 cm
Laser Beams	4,800 lines/second
Data Point Generating Rate	3,750,000 pts/s
Vertical FOV	73°
Horizontal FOV	120°

Angular Resolution	0.155°*0.146°
Frame Rate	10 FPS
Communication Interface	Industrial Ethernet
Clock Source	GPS/PTP/gPTP
Operating Voltage	9 V ~36 VDC
Operating Temperature	-40°C ~ +85°C
Storage Temperature	-40°C ~ +105°C
Shock Test	500 m/sec <sup>2</sup> , lasting for 11 ms
Vibration Test	5 Hz ~2000 Hz, 3G rms
IP Grade	IP 6K9K
Power Consumption	≤40 W
Dimensions (L*W*H)	270*160*80 mm
Weight	≤3 kg

### 1.4. Dimensions

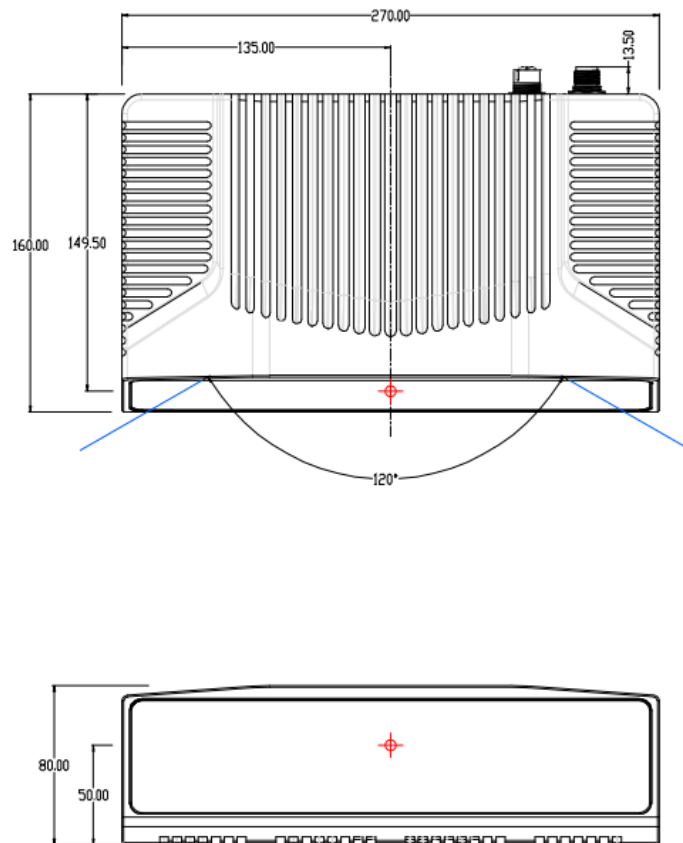

Figure 1.2 LS500W1 Mechanical Drawing

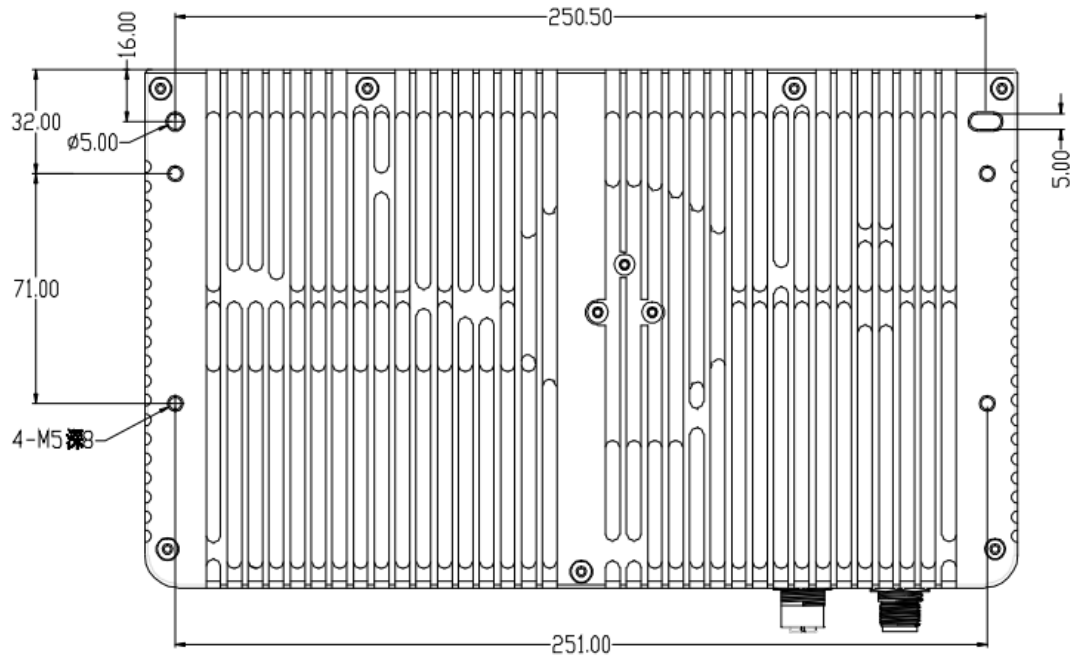

Figure 1.3 LS500W1 Lidar Mounting Drawing

**Note:**

- ① Two  $\phi 3$  dowel pins for the location holes.
- ② Four M5\*6 mm hexagon socket head cap screws to mount and fix.

## 2. Electrical Interface

### 2.1. Power Supply

The power input range of the LS500W1 lidar is 9 V ~36 VDC. Please note that DC 9 V and 36 V are short-term power supply in extreme environment, which cannot be used as working voltage. When the voltage output fluctuates, the lidar may not be able to work normally.

### 2.2. Wiring Definition

There are 2 interfaces on the side of the lidar, one is the industrial Ethernet interface: M12 X CODE 8 PIN, model number from supplier: CNT PNA: L102-M12-Z08X09. The other interface is for power supply: M12 A CODE 12 PIN, model number from supplier: CNT PNA: L102-M12-Z12A23B. The definition of the interfaces is shown as below.

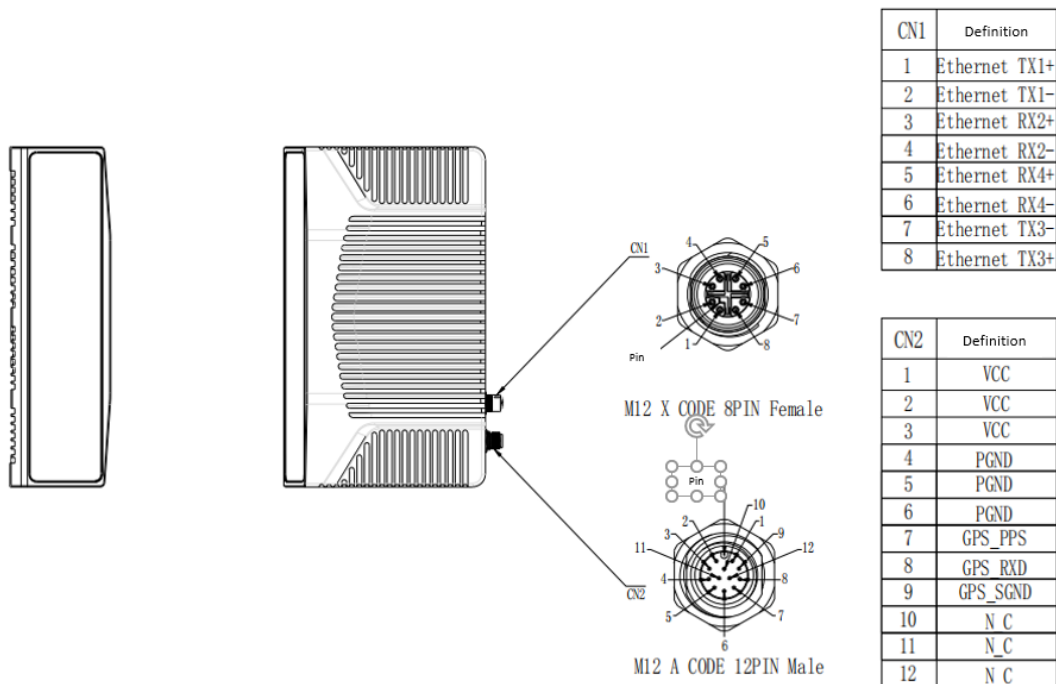

Figure 2.1 The Interfaces of the Lidar

The cables connecting to the lidar interface are one 12-pin power supply and GPS cable and one 8-pin industrial Ethernet cable. As shown below.



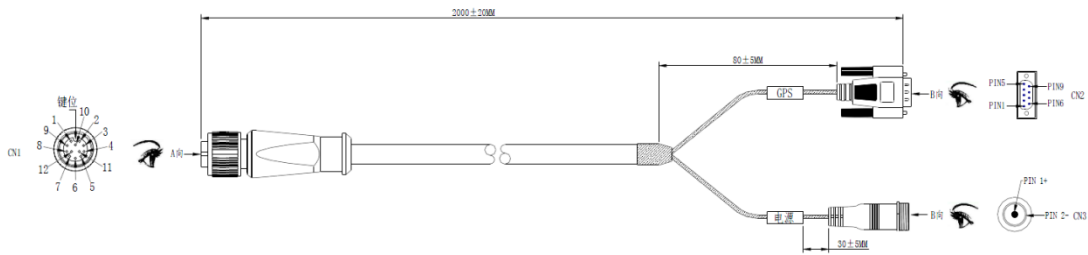

Figure 2.2 12-Pin Power Supply and GPS Cable

Table 2.1 Wiring Definition of the 12- Pin Power Supply and GPS Cable

CN1	Definition	Color	CN2	CN3	Description
1	VCC	Red	/	1	Power+
2	VCC	Brown	/		Power+
3	VCC	Orange	/		Power+
7	GPS_PPS	White	2	/	GPS PPS, External Sync PPS
8	GPS_RXD	Yellow	3	/	GPS (latitude/longitude, hour/minute/second)
9	GPS_SGND	Black	5	/	GPS Ground
4	PGND	Green	/	2	Power-
5	PGND	Blue	/		Power-
6	PGND	Grey	/		Power-
Shell	PE	Braided	Shell	/	Shell

Connectors Specifications:  
 CN1: M12 12P A CODE female connector: L102-M12-T1202A  
 CN2: D\_SUB 9 PIN male connector  
 CN3: DC5.5\*2.5 MM female connector

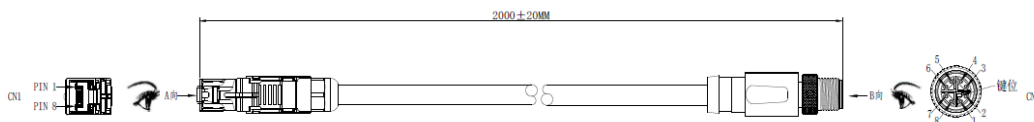

Figure 2.3 8-Pin Industrial Ethernet Cable

Table 2.2 Wiring Definition of the 8-Pin Industrial Ethernet Cable

CN1	Definition	Color	CN2	Description
1	Ethernet TX1+	Orange/White	1	1000 Base-T; Ethernet TX+
2	Ethernet TX1-	Orange	2	1000 Base-T; Ethernet TX-
3	Ethernet RX2+	Green/White	3	1000 Base-T; Ethernet RX+
6	Ethernet RX2-	Green	4	1000 Base-T; Ethernet RX-
7	Ethernet RX4+	Brown/White	5	1000 Base-T; Ethernet RX+
8	Ethernet RX4-	Brown	6	1000 Base-T; Ethernet RX-
5	Ethernet TX3-	Blue/White	7	1000 Base-T; Ethernet TX-
4	Ethernet TX3+	Blue	8	1000 Base-T; Ethernet TX+
Shell	PE	Braided	Shell	/

Connectors Specifications:  
 CN1: Shielded RJ45 8P8C Cat.6  
 CN2: M12 X CODE 8 PIN male connector: L102-M12-T08X01G

## 3. Get Ready

### 3.1. Lidar Connection

To get ready for the lidar operation, please connect the lidar and other accessories.

**Note:** Please remove the protective film on the optical window before use.

### 3.2. Software Preparation

To get ready for the lidar operation, please connect the lidar, host computer, and power supply carefully, and please remove the protective film on the lidar optical window.

### 3.2 Software Preparation

The lidar can be operated under both Windows operating system and Linux operating system. Software needed is as follows:

**Wireshark:** to capture the ARP (Address Resolution Protocol) packets.

Note: Wireshark is a third-party software that you need to download by yourself. Leishen Intelligent bears no responsibility to any copyright and commercial disputes caused by the use of this software.

To view the point cloud data generated by the lidar, you can either use the **Upper Computer Platform (Windows Client)** or the **ROS Driver Program**.

**Upper Computer Platform:** a host computer software to view point cloud image under Windows operating system, which is also referred to as “point cloud display software”.

- Software Acquisition

This Upper Computer Platform has been pre-stored in the Service Pack provided along with the lidar. It can also be obtained from the sales or technical support personnel.

- Operating Environment

This software can only run under the Windows x64 operating system at present. The computer configuration requirements for installing the software are: CPU: Intel(R) Core(TM) i5 or higher; Graphics Card: NVIDIA GeForce GTX750 or

higher achieves the best effect, otherwise the display of the point cloud may be affected. And the computer graphics card must support OpenGL 2 or higher graphics acceleration to display the point cloud normally.

- Supplemental Software

To use the Upper Computer Platform, it is necessary to install the **Npcap** third-party library, which is also included in the Upper Computer Platform installation files package.

**ROS Driver Program (optional):** to view the point cloud data under Linux operating system. This program has been included in the customer service package which can be obtained from the sales or technical support personnel.

## 4. Usage Guide

This part states operation instructions of the Upper Computer Platform and ROS driver.

### 4.1. Operation Under Windows OS

#### 4.1.1. Lidar Configuration

The default IP address and port number of the lidar network are as follows:

Table 4.1 Default Lidar Network Configuration

	IP Address	UDP Device Package Port	UDP Data Package Port
Lidar	192.168.1.200	2368 (Fixed)	2369 (Fixed)
Computer	192.168.1.102	2369	2368

**Note:**

The lidar IP (local IP) and the computer IP (destination IP) cannot be set to the same, otherwise the lidar will not work normally.

In the multicast mode, no two destination ports should be set to the same port number.

The lidar IP range are **forbidden** to be set to

- 1) Class D IP address (multicast address: i.e. 224.0.0.0~ 239.255.255.255)
- 2) Class E IP address (reserved address: i.e. 240.0.0.0~ 255.255.255.254)
- 3) Broadcast address (i.e. 255.255.255.255 and x.x.x.255 for each network segment)
- 4) Special class IP address (0.x.x.x and 127.x.x.x)

The lidar destination IP are **forbidden** to be set to

- 1) Class E IP address (i.e. 240.0.0.0 to 255.255.255.254)
- 2) Special class address (0.x.x.x and 127.x.x.x)

When connecting to the lidar, if the computer IP and the lidar IP are in different network segments, the gateway is needed to be set; if they are in the same network segment, only different IPs are needed to be set, for example: 192.168.1.x, and the subnet mask is 255.255.255.0. If you need to find the Ethernet configuration information of the lidar, please connect the lidar to the computer and use “Wireshark” to capture the ARP packet of the device for analysis. For the feature identification of the ARP packet, see the figure below.

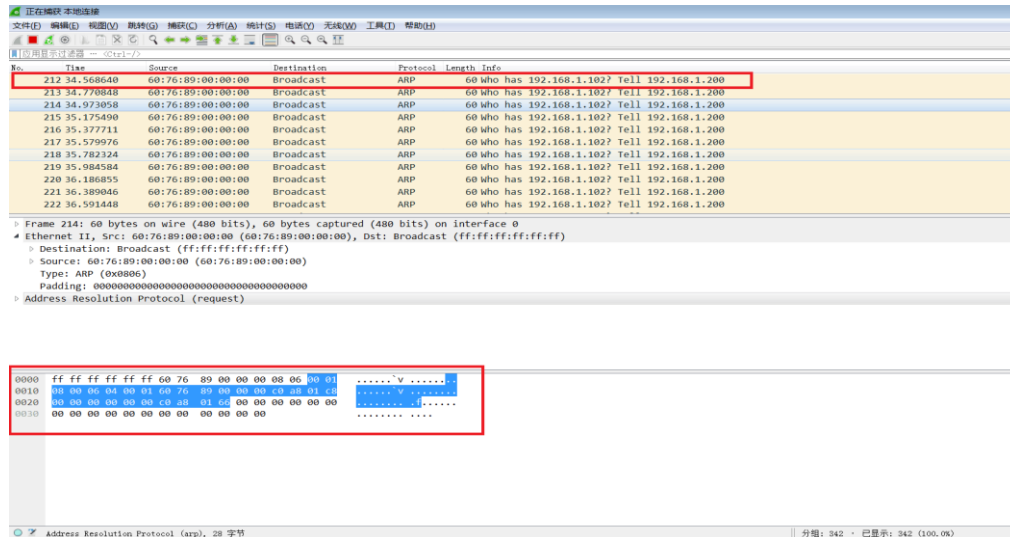



Figure 4.1 Wireshark captures APR packets

### 4.1.2. Upper Computer Platform

Upper Computer Platform (Windows Client), which is also referred to as “point cloud display software”. Simple functions like parameter configuration, lidar test and fault detection can be realized through the software, too.

For more information on how to use the software, please refer to the software operation manual included in the LiDAR service package or click on the icon  in the upper right corner of the software to jump to the software operation.

### 4.1.3. Point Cloud Data Parsing

If you need to parse lidar data, please follow the steps below:

- Step 1.** Parse the data package to obtain the relative horizontal angle, ranging information, intensity data and time information of each laser;
- Step 2.** Read the device package to obtain information such as the horizontal correction angle value, time information (GPS or PTP/gPTP time synchronization) and the current configuration of the device;
- Step 3.** Obtain the vertical angle of each line according to the laser beam distribution;
- Step 4.** According to the distance measurement value, vertical angle and the calculated horizontal angle of the point cloud data, the XYZ coordinate values are obtained;
- Step 5.** If necessary, calculate the precise time of the point cloud data through

time information, microsecond timestamp, light-emitting time of each laser, as well as single and dual echo modes;

**Step 6.** Reconfigure information such as Ethernet, PPS synchronization horizontal angle, motor speed and other information as needed, and pack the configuration package protocol.

## 4.2. ROS Driver Operation Under Linux OS

### 4.2.1. Hardware Connection and Test

**Step 1.** Connect the lidar to the internet and power supply

**Step 2.** Set the computer wired IP according to the destination IP of the lidar, (whether the computer wired IP is set successfully can be checked by the ifconfig command, as shown in the figure, the destination IP is 192.168.1.102)

```
ls@ls-Inspiron-15-3511:~$ ifconfig
enxf8e43b292f8c: flags=4163<UP,BROADCAST,RUNNING,MULTICAST> mtu 1500
  inet 192.168.1.102 netmask 255.255.255.0 broadcast 192.168.1.255
  inet6 fe80::898a:1bfd:a729:2f4e prefixlen 64 scopeid 0x20<link>
  ether f8:e4:3b:29:2f:8c txqueuelen 1000 (以太网)
  RX packets 254127 bytes 313581906 (313.5 MB)
  RX errors 254118 dropped 3 overruns 0 frame 254118
  TX packets 76 bytes 9406 (9.4 KB)
  TX errors 0 dropped 0 overruns 0 carrier 0 collisions 0
```

Figure 4.2 ifconfig Command Feedback

**Note:** The default destination IP of the lidar is 192.168.1.102, and the computer must be configured according to the actual lidar destination IP. After setting the IP for the first time, please restart the lidar.

**Step 3.** After the lidar is powered on and restarted, check the wired connection icon of the computer to see whether it is connected properly.

**Step 4.** Open the terminal: ping the lidar IP, and test whether the hardware is connected normally. If the ping is successful, then the data is received, otherwise check the hardware connection.

**Step 5.** Use “sudo tcpdump -n -i eth0” (here eth0 is the name of the wired network device, see the device name of ifconfig wired connection display for details) to view the data packets sent by the lidar (as shown in the figure, there are 1206-byte data packets sent by the lidar to the destination, which means that the lidar data is sent normally).

```
leishen@robot:~$ sudo tcpdump -n -i eth0
tcpdump: verbose output suppressed, use -v or -vv for full protocol decode
listening on eth0, link-type EN10MB (Ethernet), capture size 262144 bytes
19:49:08.973111 IP 192.168.1.200.2368 > 192.168.1.102.2368: UDP, length 1206
19:49:08.973717 IP 192.168.1.200.2368 > 192.168.1.102.2368: UDP, length 1206
19:49:08.974308 IP 192.168.1.200.2368 > 192.168.1.102.2368: UDP, length 1206
19:49:08.974913 IP 192.168.1.200.2368 > 192.168.1.102.2368: UDP, length 1206
19:49:08.975517 IP 192.168.1.200.2368 > 192.168.1.102.2368: UDP, length 1206
19:49:08.976107 IP 192.168.1.200.2368 > 192.168.1.102.2368: UDP, length 1206
19:49:08.976714 IP 192.168.1.200.2368 > 192.168.1.102.2368: UDP, length 1206
19:49:08.976888 IP 192.168.1.200.2368 > 192.168.1.102.2368: UDP, length 1206
```

Figure 4.3 sudo tcpdump -n -i eth0 Command Feedback

## 4.2.2. Software Operation Example

All the command in the following examples are for reference only, please refer to the README file in the ROS driver included in the Service Package for details

**Step 1.** Establish a workspace and build a compilation environment

```
mkdir -p ~/lidar_ws/src
```

```
cd ~/ lidar_ws
```

**Note:** The workspace can be named arbitrarily. For example, “lidar\_ws” can be changed to any name.

**Step 2.** Download the Lidar ROS driver

The ROS driver can also be obtained directly from our website or customer service. Copy the obtained driver file to the newly created workspace “src”, and decompress it.

**Step 3.** Compile and package

```
cd ~/ lidar_ws
```

```
catkin_make
```

**Step 4.** Run the program

```
source devel/setup.bash
```

```
roslaunch ls lidar_driver ls lidar_ls.launch
```

Reopen a terminal again and execute the following command:

```
roslaunch rviz rviz
```

**Note 1):** If the lidar destination port and motor speed are modified, please open “ls lidar\_ls.launch” to modify the configuration accordingly. The default data packet port is 2368, device packet port is 2369, IP address is 192.168.1.200.

**Note 2):** If timeout appears, it means that the driver has no data reception. Please check the hardware connection.

**Note 3):** If steps 1, 2, and 3 have been completed, next time after the “Displays Window” is reopened, start directly from step 4.

**Step 5.** Display the data detected by the lidar

In the “Displays Window” that pops up, modify the value of "Fixed Frame" to “laser\_link”. Click the “Add” button at the same time, and click “PointCloud2” under “By topic” to add a multi-line point cloud node.



## 5. Communication Protocol

Lidar data output and configuration use Fast Ethernet UDP/IP communication protocol. There are 3 UDP packet protocols, and the packet length is 1248 bytes (42 bytes Ethernet header and 1206 bytes payload).

The communication protocols of the lidar are:

**Main data Stream Output Protocol (MSOP):** outputting the distance, angle, intensity and other information measured by the lidar;

**Device Information Output Protocol (DIFOP):** outputting the current status of lidar and accessory equipment and various configuration information;

**User Configuration Write Protocol (UCWP):** setting the configuration parameters of the lidar.

Table 5.1 UDP Packet Protocol

Protocol Name	Abbr.	Function	Length	Transmission Interval
Main data Stream Output Protocol	MSOP	Outputting measured data and timestamp	1248 bytes	0.06712 ms
Device Information Output Protocol	DIFOP	Outputting parameter configuration and status information		1 s (for one packet)
User Configuration Write Protocol	UCWP	Inputting user configured device parameters		Not Fixed

### 5.1. MSOP Protocol

The data package outputs measured data such as the angle value, distance value, intensity value, and timestamp of the point cloud. The data of the package adopts Big-Endian mode.

The LS500W1 lidar supports single echo mode which measures the most recent echo value.

The data package includes a 42-byte Ethernet header and a 1206-byte payload, with a total length of 1248 bytes. The payload consists of 1192 bytes of point cloud data and 14 bytes of additional information (including 2 bytes reserved, 6 bytes of UTC, 4 bytes of Timestamp and 1 byte of datatype and 1 byte of hardware).

#### 5.1.1. Format

Each MSOP data packet contains 1206 bytes of data. Each packet of data

contains 149 points, that is,  $149 \times 8 = 1192$  bytes, and the frame tail is 14 bytes (including 2 bytes of package counter, 6 bytes of UTC Time or Unix Timestamp (unit: second), 4 bytes of Timestamp (unit: nanosecond) and 1 byte of lidar model and 1 byte of echo mode).

See the table below:

Header (42 Bytes)				
Measure point 1				
Measure point 2				
Measure point 3				
.....				
Measure point 149				
Counter	UTC Time/Unix Timestamp	Timestamp	Model	Echo Mode

**Note:** The lidar displays the point cloud image by frame. In the MSOP data package, if the data of the first point is FF AA BB CC DD EE 11 22, then it is the start mark of the point cloud frame (the lidar scans to the far right at this time). The start mark can be anywhere in a packet of data, not necessarily the packet header. This point is not displayed as point cloud data, but is only a judgment mark for the beginning of an image frame.

## 5.1.2. Data Package Parameter Description

### Ethernet Header

The Ethernet header has a total of 42 bytes, as shown in the table below.

Ethernet Header: 42 Bytes				
Name	S/N	Information	Offset	Length (byte)
Ethernet II MAC	0	Destination	0	6
	1	Source	6	6
Ethernet Packet Type	2	Type	12	2
Internet Protocol	3	Version, Header Length, Differentiated Services, Field, Total Length, Identification, Flags, Fragment Offset, Time to Live, Protocol, Header, Checksum, Source IP Address, Destination IP Address	14	20
UDP Port Number	4	Lidar Port (0x0941, represents 2369)	34	2
	5	Computer Port (0x0940, represents 2368)	36	2
UDP Length & Sum Check	6	Length (0x04BE, represents 1214 bytes)	38	2
	7	Sum Check	40	2

### Subframe

The subframe is the effective data area of the data packet, which contains a total of 1192 bytes, including 149 points, that is,  $149 \times 8 = 1192$  bytes. Take the first measure point as an example:

Byte 1	Byte 2	Byte 3	Byte 4	Byte 5	Byte 6	Byte 7	Byte 8
Horizontal angle [15:8]	Horizontal angle [7:0]	Vertical angle [15:8]	Vertical angle [7:0]	Distance [23:16]	Distance [15:8]	Distance [7:0]	Strength

**Byte 1** and **Byte 2** represent the horizontal angle. The most significant value in the sequence is stored first, at the lowest storage address while the least significant value is stored at the highest storage address. The unit is  $0.01^\circ$ . For example,  $0x11AD = 4525$ , that is  $45.25^\circ$ .

**Byte 3** and **Byte 4** are 16 bits in total, the high 3 bits represent the line number, and the low 13 bits represent the vertical angle value. The unit is  $0.01^\circ$ . For example,  $0x11AD = 4525$ , that is  $45.25^\circ$ .

**Byte 5**, **Byte 6**, and **Byte 7** represent the distance value, the most significant value in the sequence is stored first, at the lowest storage address while the least significant value is stored at the highest storage address. Unit: 1 mm.

To analyse the distance value, for example: the distance value in the obtained data packet is represented by the hexadecimal number  $0x01, 0x18, 0x32$ , and the first two bytes are composed of 24-bit data, that is:  $0x011832$ , which is converted to decimal distance value: 71730 mm, that is 71.73 m.

**Byte 8** represents the echo strength, and the value range is 0-255. (Echo strength can reflect the energy reflection characteristics of the measured object in the actual measurement environment. Therefore, the echo strength can be used to distinguish objects with different reflection characteristics).

**Note:** When parsing the data, the conversion from hexadecimal to decimal is a signed number.

### Azimuth

The right side of the lidar is defined as the horizontal angle of  $90^\circ$ , the left side as  $-90^\circ$ , and the vertical direction as  $0^\circ$ , as shown in the figure below. The range of the lidar's horizontal direction is  $-60^\circ$  to  $60^\circ$ .

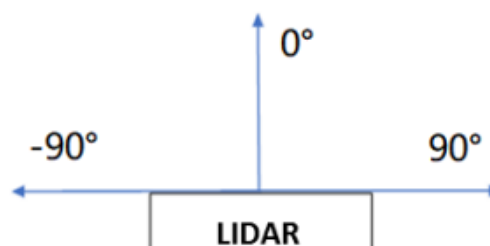

Figure 5.1 The Azimuth of the Lidar

**Additional Information**

The additional information is 14 bytes in length, including 2 bytes of package counter, 6 bytes of UTC Time or Unix Timestamp (unit: second), 4 bytes of Timestamp (unit: nanosecond), 1 byte of lidar model and 1 byte of echo mode.

Additional Information: 14 bytes			
Name		Length (byte)	Function
Package Counter		2	Loop counter, the value is increased by 1 for every package sent
Time		6	UTC Time or Unix Timestamp
Timestamp		4	Timestamp (unit: ns)
Factory	Lidar Model	1	Different value represents different model
	Echo Mode	1	0x1 represents single echo lidar 0x2 represents dual echo lidar

**5.2. DIFOP Protocol**

The device package outputs read-only parameters and status information such as version number, Ethernet configuration, motor speed and operating status, and fault diagnosis. The data of the device package adopts Big-Endian mode.

The device package includes a 42-byte Ethernet header and a 1206-byte payload, with a length of 1248 bytes. The payload is composed of an 8-byte frame header, 1196-byte data and a 2-byte frame tail.

Header is the device packet identification header, which is fixed as 0xA5,0xFF,0x00,0x5A,0x11,0x11,0x55,0x55, and the first 4 bytes can be used as the packet inspection sequence. The tail is fixed as 0x0F,0xF0.

Figure 5.2 Data Format of the Device Package

Ethernet Header: 42 bytes				
Name	S/N	Information	Offset	Length (byte)
Ethernet II MAC	0	Destination	0	6
	1	Source	6	6
Ethernet Packet Type	2	Type	12	2
Internet Protocol	3	Version, Header Length, Differentiated Services, Field, Total Length, Identification, Flags, Fragment Offset, Time to Live, Protocol, Header, Checksum, Source IP Address, Destination IP Address	14	20
UDP Port Number	4	Lidar Port (0x0940, represents 2368)	34	2
	5	Computer Port (0x0941, represents	36	2

2369)				
UDP Length & Sum Check	6	Length (0x04BE, represents 1214 bytes)	38	2
	7	Sum Check	40	2
Payload: 1206 Bytes				
Name	S/N	Information	Offset	Length (byte)
Header	0	DIFOP Identification Header	0	8
Data	1	Reserved	8	2
	2	Ethernet (IP, MAC, Port, NTP)	10	22
	3	Ethernet (Gateway, Subnet Mask)	32	8
	4	Scanning Status	40	2
	5	Device Flow Packet Interval	42	2
	6	Clock Source Selection	44	1
	7	Reserved	45	7
	8	UTC	52	6
	9	Latitude and Longitude	58	22
	10	APD Board 1 Temperature	80	2
	11	APD Board 2 Temperature	82	2
	12	APD Board 1/2 High Voltage	84	2
	13	PTP Status	86	1
	14	Reserved	87	3
	15	APD Board 3/4 High Voltage	90	2
	16	GPS Status	92	1
	17	PPS Status	93	1
	18	Fast Axis Motor Speed	94	4
	19	Reserved	98	2
	20	Frame Rate	100	1
	21	Reserved	101	1
	22	Phase Lock Switch	102	1
	23	Phase Lock Status Report	103	1
	24	Reserved	104	2
	25	Seed Status	106	2
	26	Output Light Status Detection	108	2
	27	Laser Temperature 1	110	2
	28	Laser Temperature 2	112	2
	29	Reserved	114	2
	30	Reserved	116	2
	31	Reserved	118	2
	32	Lidar's Total Operating time	120	4
	33	Operating Time Below -40°C	124	3
	34	Operating Time Below -10°C	127	3
	35	Operating Time Below 30°C	130	3
	36	Operating Time Below 70°C	133	3
	37	Operating Time Below 100°C	136	3
	38	Reserved	139	21
Tail	120	Tail	1204	2

### 5.3. UCWP Protocol

The UCWP configures the lidar's Ethernet, motor speed and other parameters, and the data of the configuration package adopts the Big-Endian mode.

The configuration packet includes a 42-byte Ethernet header and a 1206-byte payload, with a length of 1248 bytes. The payload is composed of an 8-byte Header, 1196-byte Data, and a 2-byte Tail.

Header is the configuration packet identification header, which is fixed as 0xAA,0x00,0xFF,0x11,0x22,0x22,0xAA,0xAA, and the first 4 bytes can be used as the packet inspection sequence. The tail is fixed as 0x0F,0xF0.

**Note:** It is recommended to configure the lidar through the Windows Client. Please do not package and configure the lidar parameters by yourself.

Figure 5.3 Data Format of the Configuration Package

Ethernet Header: 42 bytes				
Name	S/N	Information	Offset	Length (byte)
Ethernet II MAC	0	Destination	0	6
	1	Source	6	6
Ethernet Packet Type	2	Type	12	2
Internet Protocol	3	Version, Header Length, Differentiated Services, Field, Total Length, Identification, Flags, Fragment Offset, Time to Live, Protocol, Header, Checksum, Source IP Address, Destination IP Address	14	20
UDP Port Number	4	Lidar Port (0x0941, represents 2369)	34	2
	5	Computer Port (0x0940, represents 2368)	36	2
UDP Length & Sum Check	6	Length (0x04BE, represents 1214 bytes)	38	2
	7	Sum Check	40	2
Payload: 1206 Bytes				
Name	S/N	Information	Offset	Length (byte)
Header	0	UCWP Identification Header	0	8
Data	1	Reserved	8	2
	2	Ethernet (IP, MAC, Port, NTP)	10	22
	3	Ethernet (Gateway, Subnet Mask)	32	8
	4	Reserved	40	2
	5	Device Flow Packet Interval	42	2
	6	Clock Source Select	44	1
	7	Reserved	45	7
	8	Reserved	52	6
	9	Reserved	58	22
	10	Reserved	80	2
	11	Reserved	82	2
	12	Reserved	84	2
	13	Reserved	86	2
	14	Reserved	88	2
	15	Reserved	90	2

	16	Reserved	92	1
	17	Reserved	93	1
	18	Reserved	94	4
	19	Reserved	98	2
	20	Frame Rate	100	1
	21	Reserved	101	1
	22	Phase Lock Switch	102	1
	23	Phase Lock Status Report	103	1
	24	Reserved	104	2
	25	Reserved	106	2
	26	Reserved	108	2
	27	Reserved	110	2
	28	Reserved	112	2
	29	Reserved	114	2
	30	Reserved	116	2
	31	Reserved	118	2
	32	Reserved	120	40
Tail	120	Tail	1204	2

### 5.3.1. Configuration Parameters and Status Description

Here below are the configuration parameters and status description of specific lidar information.

#### Ethernet Configuration

The length of the source IP address “IP\_SRC” is 4 bytes and the length of the destination IP address “IP\_DEST” is also 4 bytes. Each lidar has a fixed MAC address “MAC\_ADDR” (6 bytes in length), which cannot be configured by users. Port1 is the UDP data port number and port2 is the UDP device port number.

Ethernet Configuration (22 Bytes)									
S/N	Byte1	Byte2	Byte3	Byte4	Byte5	Byte6	Byte7	Byte8	
Function	IP_SRC				IP_DEST				
S/N	Byte9	Byte10	Byte11	Byte12	Byte13	Byte14	Byte15	Byte16	
Function	MAC_ADDR (Read Only)						Data Port: Port1		
S/N	Byte17	Byte18	Byte19	Byte20	Byte21	Byte22			
Function	Device Port: Port2		Reserved						

#### Device Flow Packet Interval

Device Flow Packet Interval (2 Bytes)		
S/N	Byte0	Byte1
Function	0: send 1 device packet every time 4 data packets are sent; other values: 1 device packet per second;	

The configuration 0x0000 means to send 1 device packet every time 4 packets are sent, and other values mean 1 device packet per second. The default value is

1 (1 device packet per second).

### Time

The lidar receives GPS signals and parses the \$GPRMC information. The UTC synchronizes with GPS. The GPS baud rate supported by the lidar is 9600. There are 8 data bits, 1 stop bit and no parity bit. When there is no external clock source to synchronize time, the lidar starts internal timing.

UTC Time (6 Bytes Read Only)						
S/N	Byte1	Byte2	Byte3	Byte4	Byte5	Byte6
Function	Year	Month	Day	Hour	Minute	Second
	0~255 corresponding to the year 2000~2255	1~12 month	1~31 day	0~23 hour	0~59 min	0~59 sec

Unix Timestamp (6 Bytes Read Only)						
S/N	Byte 1	Byte 2	Byte 3	Byte 4	Byte 5	Byte 6
Function	0xff	Timestamp				

### Latitude and Longitude

Latitude and Longitude (22 Bytes Read Only)								
S/N	Byte1	Byte2	Byte3	Byte4	Byte5	Byte6	Byte7	Byte8
Function	Reserved	Latitude						
S/N	Byte9	Byte10	Byte11	Byte12	Byte13	Byte14	Byte15	Byte16
Function	Longitude							
S/N	Byte17	Byte18	Byte19	Byte20	Byte21	Byte22		
Function					N/S	W/E		

The latitude and longitude are output in the form of ASCII code.

### 5.3.2. Configuration Package Example

If you want to reset the lidar IP as 192.168.1.105, computer IP as 192.168.1.225, data port number as 6688, device port number as 8899, according to the definition of the UCWP Packet and each register, it can be reconfigured as follows:

Table 5.4 Configuration Package Example

Info	Content	Configuration	Length (byte)
Header	-	0xAA,0x00,0xFF,0x11,0x22,0x22,0xAA,0xAA	8
Reserved	Reserved	0x0000	2
Lidar IP (IP_SRC)	192.168.1.105	0xC0,0xA8,0x01,0x69	4
Computer IP	192.168.1.225	0xC0,0xA8,0x01,0xE1	4



(IP_DEST)			
Data Port (port1)	6688	0x1A20	2
Device Port (port2)	8899	0x22C3	2
Reserved	Reserved	0x0000	2
Reserved	Reserved	0x00	1180
Tail	-	0x0F,0xF0	2

When using this protocol to configure the device, byte-level or section-level addressing and writing are not allowed, and the entire list must be written completely. After the list is written, the corresponding function will be updated and take effect immediately.

## 6. Time Synchronization

There are three ways to synchronize the lidar and external clock source: GPS synchronization, PTP synchronization and gPTP synchronization. The absolute accurate time of the point cloud data is obtained by adding the 6-byte UTC Time or Unix Timestamp and the 4-byte timestamp (accurate to nanoseconds). If there is no external synchronization input, the lidar internally generates timing information.

### 6.1. GPS Synchronization

When GPS synchronization is employed, the lidar will start timing in nanoseconds after receiving the PPS, and the time value will be output as the timestamp of the data packet. The lidar extracts UTC information from the \$GPRMC of the GPS as the UTC output which is represented in both device packet and data packet.

There are two types of LS500W1 lidar GPS\_REC interface level protocols, namely TTL level standard and RS232 level standard. The two protocols differ in two aspects, respectively:

#### **TTL level pin definition:**

Pin GPS\_RX receives the standard serial port data of the TTL level output from GPS module;

Pin GPS\_PPS receives the positive TTL synchronous pulse signal output by the GPS module;

#### **RS232 pin definition:**

Pin GPS\_RX receives the standard serial data of the R232 level output from the GPS module;

Pin GPS\_PPS receives the positive synchronization pulse signal output by the GPS module, and the level is required to be 3.0 V~ 15.0 V.

If the GPS used outputs according to the RS232 serial port protocol, and the lidar receives data according to the TTL protocol, then a RS232 to TTL conversion module is needed.

The GPS equipment is time-synchronized to mark and calculate the precise emission and data measurement time of each laser. The precise time of the lidar point cloud can be matched with the pitch, roll, yaw, latitude, longitude and height of the GPS/inertial measurement system.

The default serial configuration baud rate of the GPS data output received by the lidar is 9600, 8N1. The PPS high pulse width is required to be more than 1 ms.

The standard format of GPRMC information is as follows:

\$GPRMC,<1>,<2>,<3>,<4>,<5>,<6>,<7>,<8>,<9>,<10>,<11>,<12> \*hh

Table 6.1 The Standard Format of \$GPRMC Information

S/N	Name	Description/Format
1	UTC	hhmmss (hour/minute/second)
2	Positioning State	A=Effective Positioning, V=Invalid Positioning
3	Latitude	ddmm.mmmm (degree/minute)
4	Latitude Hemisphere	N (Northern Hemisphere) or S (Southern Hemisphere)
5	Longitude	dddmm.mmmm (degree/minute)
6	Longitude Hemisphere	E (East Longitude) or W (West Longitude)
7	Ground Speed	000.0~999.9 knot
8	Ground Direction	000.0~359.9 degree, take true north as the reference datum
9	UTC Date	ddmmyy (day/month/year)
10	Magnetic Declination	000.0~180.0 degree
11	Direction of Magnetic Declination	E (East) or W (West)
12	Mode Indication	Only NMEA0183 version 3.00 outputs, A= autonomic positioning, D= difference, E=estimation, N=invalid data

## 6.2. PTP/gPTP Synchronization

Precise Time Protocol (PTP) is used for high-precision time synchronization between devices in an accuracy within sub-microsecond for measurement and control systems.

Generalized Precise Time Protocol (gPTP) is derived from Precise Time Protocol (PTP) and is used to synchronize the time of individual devices within a local area network with high precision.

The PTP supported by this series of lidar transmits over MAC or IPv4 (IPv6 not supported) and works in P2P mode (Peer to Peer), and its synchronization method is Two-Step.

Before synchronizing the lidar via PTP/gPTP, the time source needs to be set to “PTP” in the lidar's point cloud display software. The lidar can automatically identify PTP and gPTP packet types.

The steps are as follows: open the point cloud display software, click on “” to bring up the parameter modification window, select “PTP” from the “Source Selection” drop-down list as shown in the figure below.

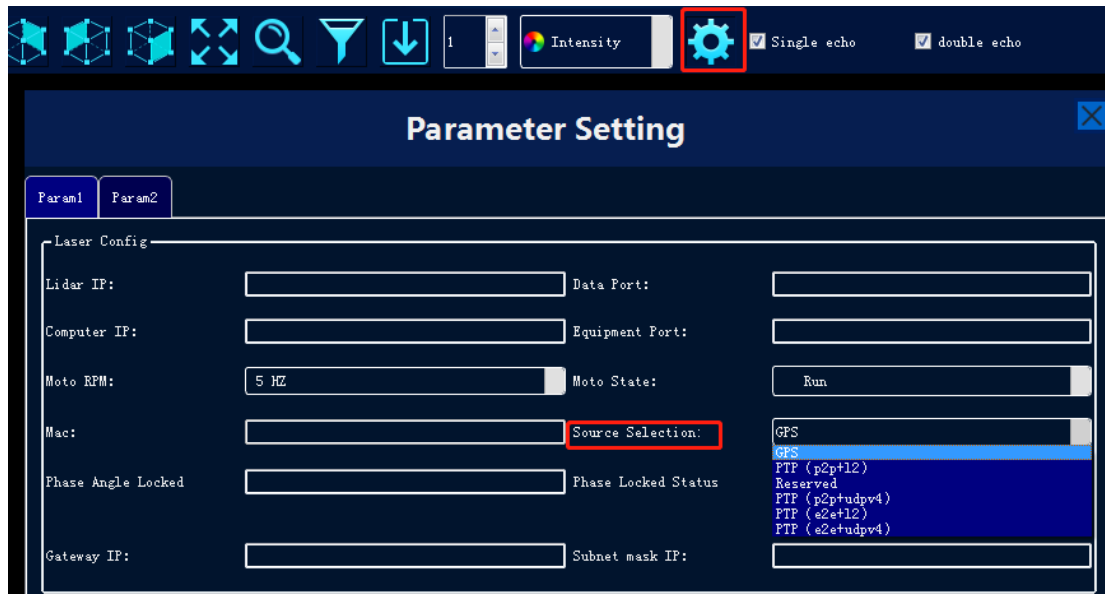

Figure 6.1 Clock Source Selection

#### Note:

- When “PTP” is selected as the clock source, the lidar no longer outputs UTC Time.
- The Timestamp and Date & Time in the point cloud packets will be synchronized strictly according to the time signal provided by the PTP/gPTP master. There may be a specified offset between some PTP/gPTP master and the lidar’s time output, please make sure the PTP/gPTP master is properly set up and calibrated.
- If the lidar disconnected from the master after time synchronization, it will continue timing from the time of the interruption.

### 6.3. Lidar Internal Timing

When the lidar disconnected from the external clock source after time synchronization, then the lidar will continue timing from the time of the interruption.

When there is no other external clock source after-power on, the lidar will start internal timing and the timing value will be output as a timestamp of the data packet without UTC time reference. At this time, there would be 2 different cases in terms of time display on the point cloud display software: when the clock source is set to "GPS", the time will be counted from January 1, 2000, 00:00:00; when the time source is set to "PTP", the time will be counted from January 1, 1970, 00:00:00.

## 7. Angle and Coordinate Calculation

In order to obtain the vertical angle, horizontal angle and distance parameters of the lidar, the angle and distance information in polar coordinates can be converted to the x, y, z coordinates in the right-hand Cartesian coordinate system. The conversion relationship is shown in the following formula:

$$\begin{cases} x = r \cos \alpha \cos \theta; \\ y = r \cos \alpha \sin \theta; \\ z = r \sin \alpha \end{cases}$$

In the above formula,  $r$  is the distance,  $\alpha$  is the vertical angle,  $\theta$  is the horizontal rotation angle (the horizontal correction angle needs to be considered when calculating). And  $x$ ,  $y$ , and  $z$  are the coordinates of the polar coordinates projected onto the  $x$ ,  $y$ , and  $z$  axes.

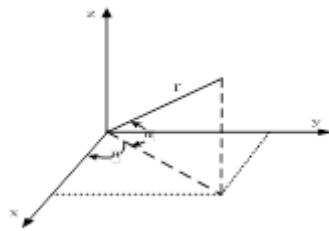

Figure 7.1 Coordinate Mapping

## Appendix A. Maintenance

### Shipping Requirements

LS series lidars use packaging materials specially customized by our company, which can resist certain vibrations and impacts. For long-distance transportation, special packaging materials must be used to avoid irreversible damage during transportation.

### Installation

Use screws that meet the specifications to fix the lidar base, and make sure the base has good heat dissipation. Wear powder-free clean gloves during installation to avoid optical cover contamination and mechanical damage.

### Storage Conditions

It is recommended to store the products in a ventilated and dry place where the temperature is  $23\pm 5$  °C, and the relative humidity is 30% ~ 70%. Do not store in environments where humidity, pH, etc. exceed the protection level.

### Dirt Treatment

If the mask is dirty during use, such as with fingerprints, muddy water, dry leaves or insect corpses, etc., the lidar's ranging effect will be directly affected. Please clean it according to the following steps:

Tools: PVC gloves, clean cloth, absolute ethanol (99%)

Environment: ventilated and dry, away from fire

(1) Put on PVC gloves and fix the lidar base with your fingers; if it is not stubborn stains, use a dust-free cloth or dry air to gently remove the stains;

(2) For stubborn stains, evenly spray the ethanol in the spray bottle on the location to be cleaned and wait for the stain to be dissolved. Then use a dustless cloth dipped in ethanol solvent, and gently wipe the mask. If the cloth is contaminated, please replace it in time. After cleaning the stain, use a new dustless cloth to remove any remaining liquid.

## Appendix B. Troubleshooting

For any of the following problems during the use of the lidar, please refer to the corresponding solutions for troubleshooting. If you are unable to implement the following steps, or if you are still unable to solve the problem after implementing the steps, please contact our technical support.

Problem	Solution
The indicator light on the interface box is not working	Confirm: <ul style="list-style-type: none"> <li>● power supply meets electrical requirements</li> <li>● interface box is in good condition with no damage</li> <li>● power cord contact is good and undamaged; power adapter is working properly</li> <li>● re-power the lidar to see if the fault disappears</li> </ul>
Motor is not running	Confirm: <ul style="list-style-type: none"> <li>● power supply meets electrical requirements</li> <li>● good contact between interface box and the lidar</li> <li>● re-power the lidar to see if the fault disappears</li> </ul>
Motor running but no data output on the host PC or Wireshark	Confirm: <ul style="list-style-type: none"> <li>● power supply meets electrical requirements</li> <li>● the network cable is well connected</li> <li>● the IP address of the computer matches the destination IP address of the lidar</li> <li>● your computer's firewall and other security software that may affect Ethernet broadcasts is turned off</li> <li>● if the lidar emits laser beam with an IR camera or IR card</li> <li>● re-power the lidar to see if the fault disappears</li> </ul>
Wireshark has data but the host PC has no data	Confirm: <ul style="list-style-type: none"> <li>● your computer's firewall is turned off</li> <li>● the IP address of the computer matches the destination IP address of the lidar</li> <li>● data port and device port in the host computer are set correctly</li> <li>● lidar port is not occupied by another process</li> <li>● Npcap plugin is installed</li> <li>● re-power the lidar to see if the fault disappears</li> </ul>
Point cloud missing	Confirm: <ul style="list-style-type: none"> <li>● lidar housing is clean and free of stains</li> <li>● horizontal FOV setting in the host computer</li> <li>● the number of packets received by the lidar is normal</li> <li>● whether the lidar emits laser beams, this can be checked with an IR camera or an IR card</li> <li>● whether there are network conflicts</li> <li>● whether there is a network blockage caused by other devices transmitting large amounts of data</li> <li>● connect the PC to the lidar only and observe if the point cloud is missing</li> <li>● re-power the lidar to see if the fault disappears</li> </ul>
Abnormal point cloud image on the host PC (flickering point cloud;	Confirm: <ul style="list-style-type: none"> <li>● the lidar housing is clean and free of stains</li> <li>● lidar surroundings are not complex</li> </ul>



<p>irregular point cloud alignment)</p>	<ul style="list-style-type: none"> <li>● horizontal FOV setting in the host computer</li> <li>● whether the network is blocked by other devices transmitting data</li> </ul>
<p>Error occurs when running the Windows Client, no interface display</p>	<p>Confirm:</p> <ul style="list-style-type: none"> <li>● the graphics card is used correctly, discrete graphics card is recommended</li> <li>● the graphics card meets the minimum configuration requirements</li> <li>● the driver for the graphics card is correctly installed</li> </ul>
<p>Crash or no response of the Windows Client when modifying lidar parameters</p>	<p>Confirm:</p> <ul style="list-style-type: none"> <li>● Npcap plugin is installed</li> <li>● the device package port number is correctly filled in</li> <li>● the computer memory is not full</li> </ul>

## Revision History

Rev.	Release Date	Revised Content	Issued/Revised By
V1.0.0	2023-10-31	Initial Version	Leishen
V1.0.1	2024-04-16	Specifications updated	LS1499
V1.0.2	2024-05-31	MSOP protocol modified	LS1499

\*This product information is subject to change without notice.

Copyright ©2024 Leishen Intelligent System Co., Ltd. All rights reserved.



**Make Safer Driving  
Smarter Machine  
and Better Life !**



Official Website: <https://www.lslidar.com>



Sales: [sales@lslidar.com](mailto:sales@lslidar.com)

After-Sales: [support@lslidar.com](mailto:support@lslidar.com)