



MS06-B

User Manual

V1.0.2 202.04



Safety Instruction

Before using the product, please read and follow the instructions of this manual carefully, and refer to relevant national and international safety regulations.

ΔAttention

Please do not disassemble or modify the lidar privately. If you need special instructions, please consult our technical support staff.

ΔLaser Safety Level

The laser safety of this product meets the following standards:

- IEC 60825-1:2014
- 21 CFR 1040.10 and 1040.11 standards, except for the deviations (IEC 60825-1, third edition) stated in the Laser Notice No. 56 issued on May 8, 2019. Please do not look directly at the transmitting laser through magnifying devices (such as microscope, head-mounted magnifying glass, or other forms of magnifying glasses).

Eye Safety

The product design complies with Class 1 human eye safety standards. However, to maximize self-protection, please avoid looking directly at running products.



ΔSafety Warning

In any case, if the product is suspected to have malfunctioned or been damaged, please stop using it immediately to avoid injury or further product damage.

Housing

The product contains high-speed rotating parts, please do not operate unless the housing is fastened. Do not use a product with damaged housing in case of irreparable losses. To avoid product performance degradation, please do not touch the photomask with your hands.

Operation

This product is composed of metal and plastic, which contains precise circuit electronic components and optical devices. Improper operations such as high temperature, drop, puncture or squeeze may cause irreversible damage to the product.

Power Supply

Please use the connecting cable and matching connectors provided with the lidar to supply power. Using cables or adapters that are damaged or do not meet

the power supply requirements, or supply power in a humid environment may cause abnormal operation, fire, personal injury, product damage, or other property loss.

Light Interference

Some precise optical equipment may be interfered with by the laser emitted by this product, please pay attention when using it.

Vibration

Please avoid product damage caused by strong vibration. If the product's mechanical shock and vibration performance parameters are needed, please contact us for technical support.

Radio Frequency Interference

The design, manufacture and test of this product comply with relevant regulations on radiofrequency energy radiation, but the radiation from this product may still cause other electronic equipment to malfunction.

Deflagration and Other Air Conditions

Do not use the product in any area with potentially explosive air, such as areas where the air contains high concentrations of flammable chemicals, vapours or particles (like fine grains, dust or metal powder). Do not expose the product to the environment of high-concentration industrial chemicals, including near evaporating liquefied gas (like helium), so as not to impair or damage the product function.

Maintenance

Please do not disassemble the lidar without permission. Disassembly of the product may cause its waterproof performance to fail or personal injury.

TABLE OF CONTENTS

1. PRODUCT PROFILE	1
1.1 OVERVIEW	1
1.2 MECHANISM	1
1.3 SPECIFICATIONS	1
1.4 DIMENSIONS	2
2. ELECTRICAL INTERFACE	3
2.1 POWER SUPPLY	3
2.2 WIRING DEFINITION	3
3. GET READY	5
3.1 LIDAR CONNECTION	5
3.2 SOFTWARE PREPARATION	5
4. USAGE GUIDE	7
4.1 OPERATION UNDER WINDOWS OS	7
4.1.1 Lidar Configuration	7
4.1.2 Windows Client Interface	8
4.1.3 Operation Procedure	10
4.1.4 Point Cloud Data Parsing	11
4.1.5 Note	11
4.2 ROS DRIVER OPERATION UNDER LINUX OS	14
4.2.1 Hardware Connection and Test	14
4.2.2 Software Operation Example	15
5. COMMUNICATION PROTOCOL	17
5.1 MSOP PROTOCOL	17
5.1.1 Format	17
5.1.2 Data Package Parameter Description	18
5.2 DIFOP PROTOCOL	20
5.3 UCWP PROTOCOL	22
5.3.1 Configuration Parameters and Status Description	23

5.3.2 Configuration Package Example	24
6. TIME SYNCHRONIZATION	26
6.1 GPS SYNCHRONIZATION	26
6.2 EXTERNAL SYNCHRONIZATION	27
6.3 GPTP SYNCHRONIZATION	27
6.4 LIDAR INTERNAL TIMING.....	28
7. ANGLE AND COORDINATE CALCULATION	29
APPENDIX A. MAINTENANCE	30
APPENDIX B. TROUBLESHOOTING.....	31

1. Product Profile

1.1 Overview

The MS06-B is a lidar based on time-of-flight mechanism. It has a wide FOV of 120°*40°, a detecting distance of up to 1200 m, a range accuracy of ±3 cm and a minimum angular accuracy of 0.02°, which make it ideal for mapping applications.

1.2 Mechanism

The MS06-B lidar adopts the Time of Flight (ToF) method. The lidar starts timing (t_1) when the laser pulses are sent out. And when the laser encounters the target object and the light returns to the sensor unit, the receiving end stops timing (t_2).

$$\text{Distance} = \text{Speed of Light} * (t_2 - t_1) / 2$$

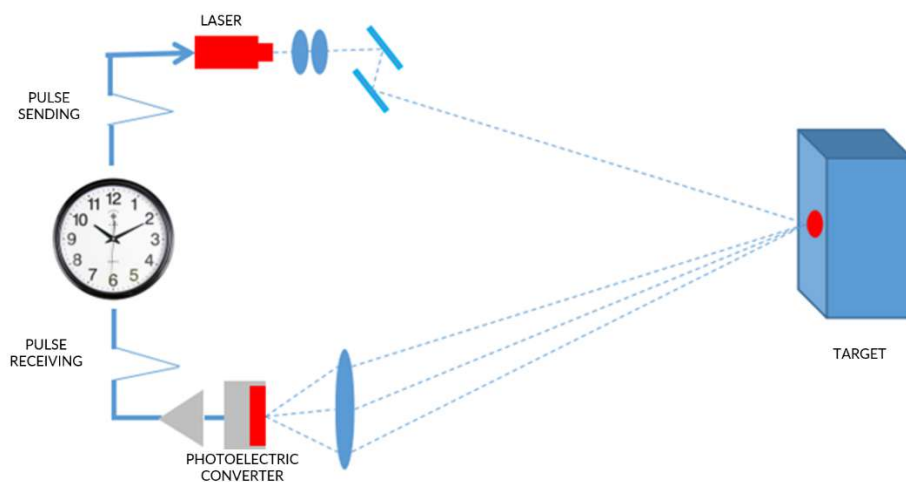

Figure 1.1 Mechanism of the MS06-B Lidar

1.3 Specifications

Table 1.1 Specifications of MS06-B

Model	MS06-B
Detection Method	ToF
Wavelength	1550 (±25) nm
Laser Class	Class 1 (eye-safe)
Detection Range	1200 m (Max.)
Range Accuracy	±3 cm
Data Point Generated	400,000 pts/sec
Vertical FOV	40°
Horizontal FOV	120°

Angular Resolution (H*V)	0.24°*0.05°
Angular Precision	0.02°
Scanning Rate	1 Hz
Communication Interface	Fast Ethernet
GNSS Interface	422 Sync Pulse
Operating Voltage	28 VDC
Power Consumption	100 W
Operating Temperature	-45°C~+70°C
Storage Temperature	-55°C~+85°C
IP Grade	IP 67
Dimensions	242.3*220*96 mm
Weight	About 4.0 kg

1.4 Dimensions

Here below is the mechanical drawing of MS06-B lidar.

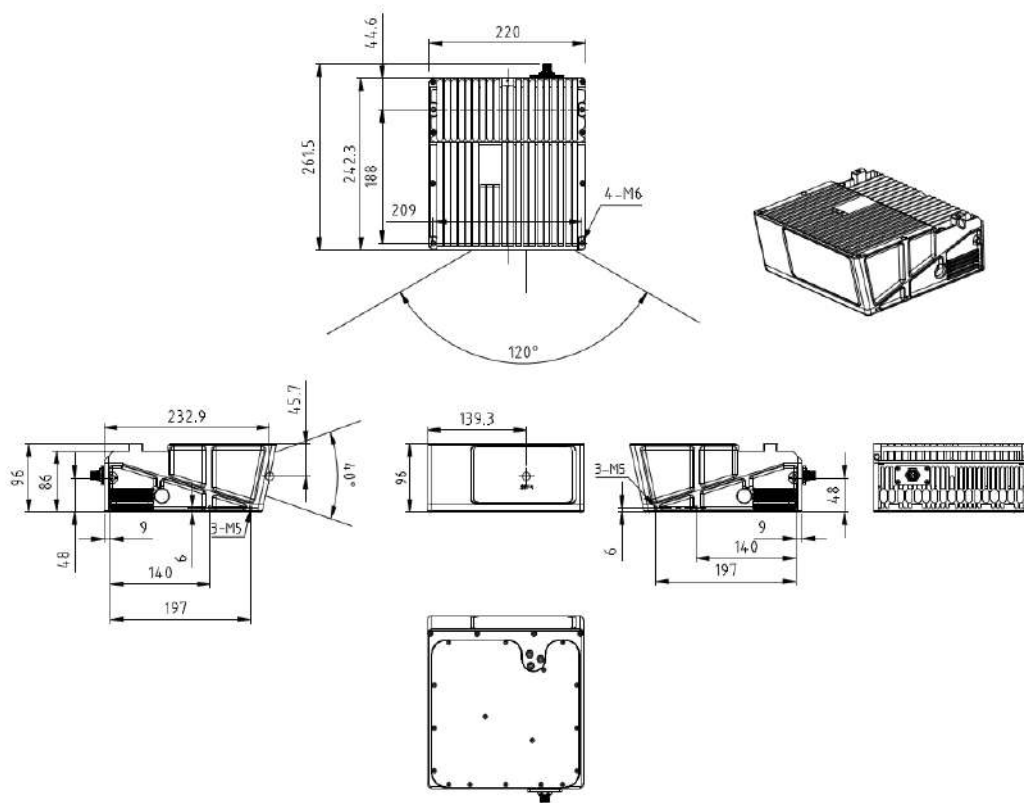

Figure 1.2 MS06-B Mechanical Drawing

2. Electrical Interface

2.1 Power Supply

The power input to the MS06-B lidar is 28 VDC. Please keep the voltage output fluctuations within 10%, otherwise the lidar may not be able to work normally.

2.2 Wiring Definition

The lidar connector of MS06-B lidar is as shown below.

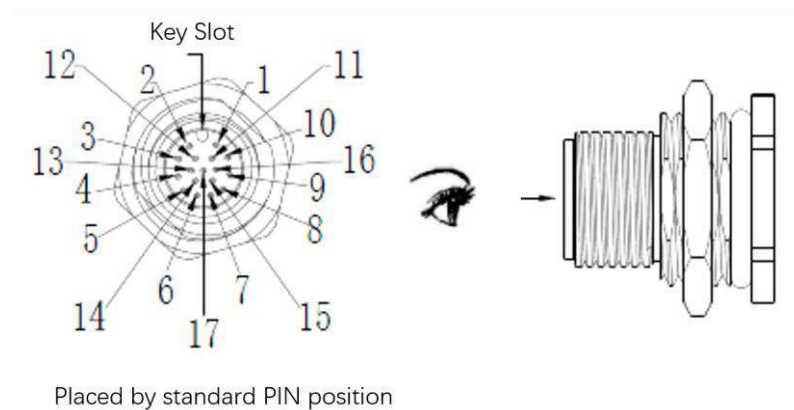

Figure 2.1 MS06-B Lidar Connector

Table 2.1 Wiring Definition of the Lidar Connector

Lidar Connector PIN	Definition	Description
2	Ethernet TX1+	Ethernet TX+ (lidar→external devices)
3	Ethernet TX1-	Ethernet TX- (lidar→external devices)
6	Ethernet RX2-	Ethernet RX- (external devices→lidar)
7	Ethernet RX2+	Ethernet RX+ (external devices→lidar)
4	RS422_PPS_RX+	RS422 PPS RX+ (external devices→lidar)
5	RS422_PPS_RX-	RS422 PPS RX- (external devices→lidar)
8	RS422_RX1+	RS422 RX+ (external devices→lidar)
9	RS422_RX1-	RS422 RX- (external devices→lidar)
1	RS422_SGND	RS422 signal ground
10	Power	Power+
11	Power	Power+
12	Power	Power+
13	Power	Power+
14	PGND	Power-
15	PGND	Power-

16	PGND	Power-
17	PGND	Power-
Shell	PE	Shield ground

The cable from the side of the MS06-B lidar is a 17-pin industry ethernet cable.

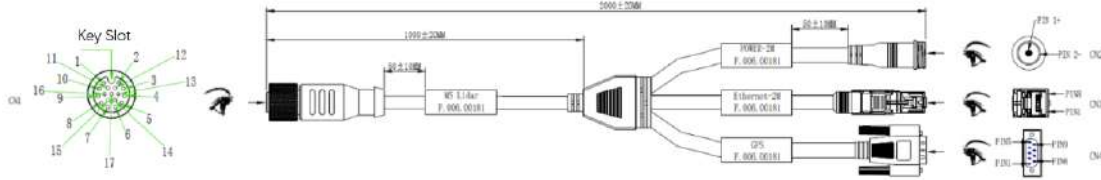

Figure 2.2 The 17-PIN Industry Ethernet Cable

Table 2.2 Wiring Definition of the 17-PIN Industry Ethernet Cable

CN1 PIN	CN1 PIN Color	Definition	Description	CN2/CN3/CN4 PIN	CN2/CN3/CN4 PIN Color
2	Orange/White	Ethernet TX1+	Ethernet TX+ (lidar→external devices)	CN3-1	Orange/White
3	Orange	Ethernet TX1-	Ethernet TX- (lidar→external devices)	CN3-2	Orange
6	Green	Ethernet RX2-	Ethernet RX- (external devices→lidar)	CN3-6	Green
7	Green/White	Ethernet RX2+	Ethernet RX+ (external devices→lidar)	CN3-3	Green/White
4	Blue/White	RS422_PPS_RX+	RS422 PPS RX+ (external devices→lidar)	CN4-1	Orange/White
5	Blue	RS422_PPS_RX-	RS422 PPS RX- (external devices→lidar)	CN4-2	Orange
8	Brown/White	RS422_RX1+	RS422 RX+ (external devices→lidar)	CN4-3	Blue/White
9	Brown	RS422_RX1-	RS422 RX- (external devices→lidar)	CN4-4	Blue
1	Blue	RS422_SGND	RS422 signal ground	CN4-5	Black
10	Red	Power	Power+	CN2-1	Red
11	Red	Power	Power+		
12	Red	Power	Power+		
13	Yellow	Power	Power+	CN2-2	Black
14	White	PGND	Power-		
15	Black	PGND	Power-		
16	Black	PGND	Power-		
17	Black	PGND	Power-		
Shell	Braided	PE	Shield ground	CN3/CN4-PE	Braided

3. Get Ready

3.1 Lidar Connection

To get ready for the lidar operation, please connect the lidar properly and please remove the protective film on the optical window before use.

3.2 Software Preparation

The MS06-B lidar can be operated under both Windows operating system and Linux operating system. Software needed is as follows:

Wireshark: to capture the ARP (Address Resolution Protocol) packets.

Note: Wireshark is a third-party software, and you may need to download it by yourself. LeiShen Intelligent bears no responsibility for any copyright and commercial disputes caused by users' use of the software.

To view the point cloud data generated by the lidar, you can either use the **Windows Client** or the **ROS Drive Program**.

Windows Client (optional): a host computer software to view point cloud image under Windows operating system, which is also referred to as "point cloud display software". Simple functions like parameter configuration, lidar test and fault detection can be realized through the client, too.

- Software Acquisition

This Windows Client has been pre-stored in the USB flash drive provided along with the lidar. It can also be obtained from the sales or technical support personnel. No installation is required to the client.

- Operating Environment

This software can only run under the Windows x64 operating system at present. The computer configuration requirements for installing the software are: CPU: Intel(R) Core (TM) i5 or higher; Graphics Card: NVIDIA GeForce GTX750 or higher achieves the best effect, otherwise the display of the point cloud may be affected. And the computer graphics card must support OpenGL 2 or higher graphics acceleration to display the point cloud normally.

- Supplemental Software

To use the Windows Client, it is necessary to install the **WinPcap** third-party library. This software has also been pre-stored in the USB flash drive provided with the lidar.

To install the WinPcap software, please follow the following steps:

Step 1. Insert the USB driver into computer port and open it.

Step 2. Find the WinPcap installation file and double-click it to initiate the installation.

Step 3. Click “next” to enter the installation path selection interface.

Step 4. Click “next” to enter the installation interface.

Step 5. Click the “install” button, and wait for the installation to be completed.

ROS Drive Program (optional): to view the point cloud data under Linux operating system. This program has been pre-stored in the USB flash drive provided with the lidar. It can also be obtained from the sales or technical support personnel. No installation is required.

4. Usage Guide

This part states operation instructions of the Windows Client and ROS drive presented by the LeiShen Intelligent System Co. Ltd.

4.1 Operation Under Windows OS

4.1.1 Lidar Configuration

The default IP address and port number of the lidar network are as follows:

Table 4.1 Default Lidar Network Configuration

	IP Address	UDP Device Package Port	UDP Data Package Port
Lidar	192.168.1.200	2368 (Fixed)	2369 (Fixed)
Computer	192.168.1.102	2369	2368

Note: The lidar IP (local IP) and the computer IP (destination IP) cannot be set to the same, otherwise the lidar will not work normally.

In the multicast mode, no two destination ports should be set to the same port number.

The lidar IP range are **forbidden** to be set to

- 1) Class D IP address (multicast address: i.e. 224.0.0.0~ 239.255.255.255)
- 2) Class E IP address (reserved address: i.e. 240.0.0.0~ 255.255.255.254)
- 3) Broadcast address (i.e. 255.255.255.255 and xx.x.255 for each network segment)
- 4) Special class IP address (0.x.xx and 127.xxx)

The lidar destination IP are **forbidden** to be set to

- 1) Class E IP address (i.e. 240.0.0.0 to 255.255.255.254)
- 2) Special class address (0.x.xx and 127.x.x.x)

When connecting to the lidar, if the computer IP and the lidar IP are in different network segments, the gateway is needed to be set; if they are in the same network segment, only different IPs are needed to be set, for example: 192.168.1.x, and the subnet mask is 255.255.255.0. If you need to find the Ethernet configuration information of the lidar, please connect the lidar to the computer and use “Wireshark” to capture the ARP packet of the device for analysis. For the feature identification of the ARP packet, see the figure below.

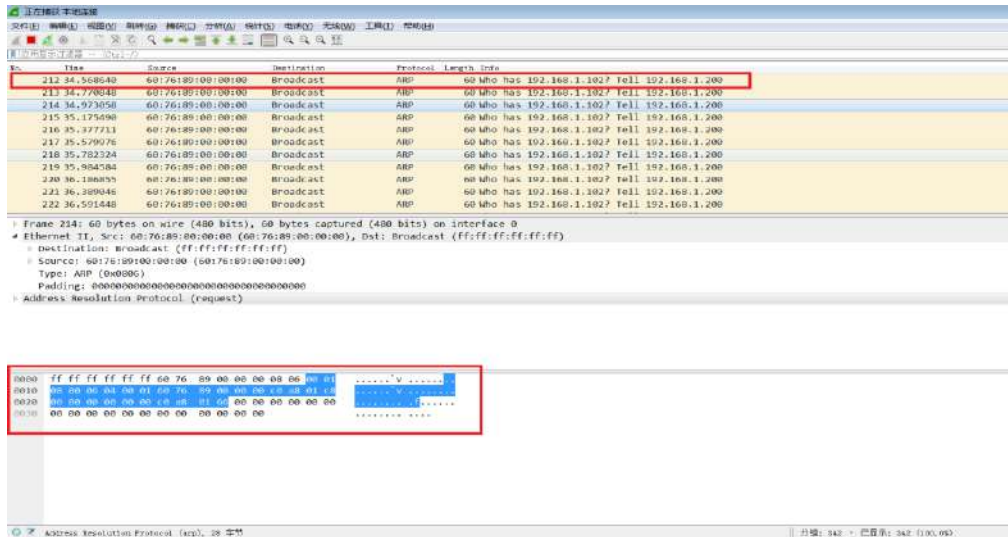

Figure 4.1 Wireshark captures APR packets

4.1.2 Windows Client Interface

The software interface includes menu area, tool bar area, 3D window area, data table area, etc.

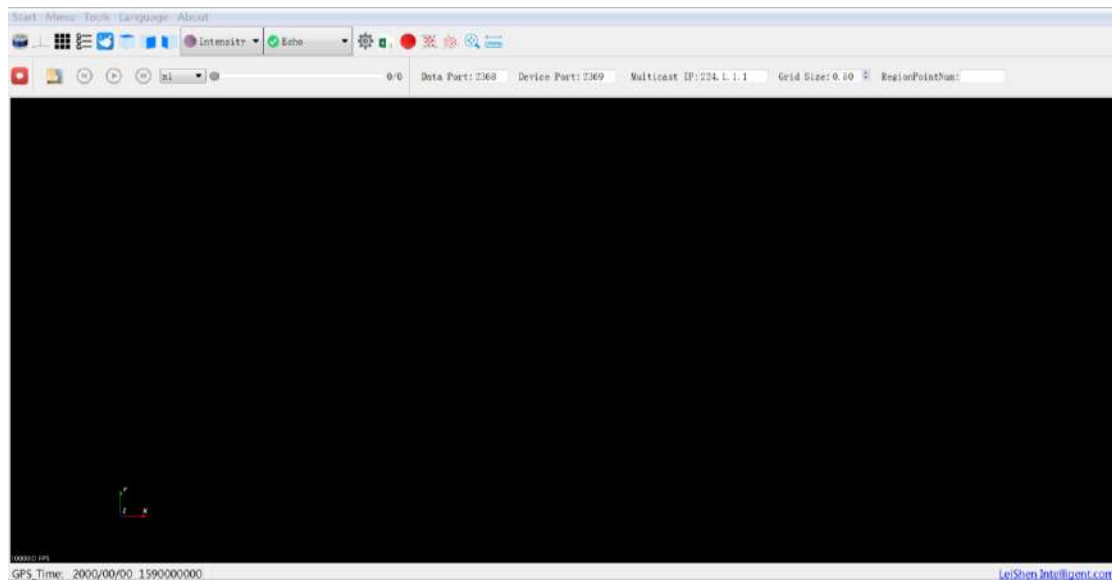

Figure 4.2 Initial Interface

Note: To view the software version, click “Help->About” in the toolbar.











Point cloud display interface supports the following operations:

- 1) Zoom in/out the display interface with the mouse wheel; hold the right mouse button and drag it up/down to zoom in/out;
- 2) Hold the left mouse button and drag it to adjust the angle of view;

3) Hold the mouse wheel and drag it to pan the display interface; or hold the shift key on the keyboard and the left mouse button to pan the interface.

Menu button function introduction





● Lidar Menu



Button	Description
 Lidar	Click to start receiving point cloud data
 MeaGrid	Show/hide measurement grid
 Select	Mark the selected points in the point cloud image
 Suspend Data	Pause point cloud image and data generating
	Select point clouds from different angles
	Zoom in/out
	Measure the distance between two points
 Clear	Clear screen
 Coordinate	Show/hide coordinate
 LidarDataList	Show/hide the column on the left

Note: In the point cloud display area, with 20 circles and 40*40 grids, the radius of every two adjacent circles differs by 10 m. The difference between each two grids (horizontal or longitudinal) is 10 m. And the radius of the outermost circle is 200 m.







The grids and circles make it easy to view the position of the point cloud. The direction of the coordinate axis in the 3D display interface is consistent with the direction of the X-Y axis in the point cloud reference system.

● Offline Menu

Button	Description
 Open	Open offline data
 Record	Record and saved data, valid only when lidar receives data in real time
	Skip to the beginning
	Click to start playing after the point cloud file is loaded When playing, click to pause

	Skip to the end
	Adjust the play speed of the offline point cloud file
	Drag the progress bar or enter the frame number to skip to a specified position

● Setup Menu

Button	Description	
	Open lidar parameter form	The upper part of the form shows the lidar configuration. The parameters include local IP, destination IP, subnet mask, gateway, data port, device port, and motor speed setting (different speed can be selected under combobox), whether to obtain the local time, Mac address information, and device packet sending interval. The lower part shows the real-time status information. According to the DIFOP status packet sent out regularly by the lidar, the current status information is displayed, including GPS position information, satellite time information, motor speed, current lidar IP, and current lidar port number.
	Select laser channel	Vertical Angle column represents the vertical angle of the corresponding channel data and Channel column represents the data sequence number corresponding to the channel.
	Select a perspective (front, top, left) to observe the point cloud image	
	Save the data in .csv format	The data includes Points_X, Points_Y, Points_Z, Laser_id, Azimuth, Distance, Intensity.
	Set the display mode of the point cloud	Intensity, laser ID, azimuth angle, etc.
	Set echo mode	

Note: The computer graphics card must support OpenGL 2 or higher graphics acceleration to display the point cloud normally.

4.1.3 Operation Procedure

Step 1. Set the data port number (default 2368), device port (or telemetry port

in the picture below) number (default 2369). 

Step 2. When the power supply of the lidar is connected to the network cable,

click  to receive the lidar data in real time.

Step 3. The data table contains ID, Points_m_XYZ, Distance, Azimuth, Intensity, in which ID is the lidar channel number; Points_m_XYZ are the coordinates; Distance is the distance value; Azimuth is the azimuth angle; and Intensity is the

reflection intensity.

4.1.4 Point Cloud Data Parsing

If you need to parse lidar data, please follow the steps below:

Step 1. Parse the data package to obtain the relative horizontal angle, ranging information, intensity data and microsecond timestamp information of each laser;

Step 2. Read the device package to obtain information such as the horizontal correction angle value, UTC (GPS or NTP time service) and the current configuration of the device;

Step 3. Obtain the vertical angle of each line according to the laser beam distribution;

Step 4. According to the distance measurement value, vertical angle and the calculated horizontal angle of the point cloud data, the XYZ coordinate values are obtained;

Step 5. If necessary, calculate the precise time of the point cloud data through UTC, microsecond timestamp, light-emitting time of each laser, as well as single and dual echo modes;

Step 6. Reconfigure information such as Ethernet, PPS synchronization horizontal angle, motor speed and other information as needed, and pack the configuration package protocol.

4.1.5 Note

Notice about the lidar setting and usage:

- 1) It is not possible to use LS Windows Client to receive data in two processes (open twice at the same time) on the same computer. The port occupancy of the PC is generally exclusive, so the other software that uses the same process or the same port number cannot work normally after a process is bound to a specified port number. When LS Windows Client detects that the port is occupied, it will prompt that the communication network port configuration has failed, and automatically close the software. You need to close the software process that occupied the port, and reopen the Client to use it normally.
- 2) At the same time, since Qt is adopted in the low-level software development, please create English paths when naming files and path folders.
- 3) Since the port number of the lidar can be modified through user configuration, and the lidar sends data to the host computer through the

preset destination IP and port. Therefore, when the local laptop or desktop computer and other devices are receiving data, their IP address should be the same as the destination IP, and the port bound to the local host computer program needs to be the same as the destination port number, as shown in the figure below (these are the data packet parameters captured and analysed by Wireshark software). The data in the red boxes indicate the destination IP and port number of the lidar.

Time	Source	Destination	Protocol	Length	Info
1 0.000000	192.168.3.208	192.168.3.144	UDP	1248	2368 → 2368 Len=1206
2 0.000704	192.168.3.208	192.168.3.144	UDP	1248	2368 → 2368 Len=1206
3 0.001318	192.168.3.208	192.168.3.144	UDP	1248	2368 → 2368 Len=1206

Figure 4.3 Data Packet Parameters Captured by Wireshark Software

Please set the host computer IP according to the following steps:

Step 1. In the Control Panel -> All Control Panel Items -> Network Connections, click the “Ethernet” icon.

Step 2. Click “Properties” in the pop-up status box, and click “TCP/IPv4 protocol” in the pop-up Ethernet properties box, as shown in the figure below.

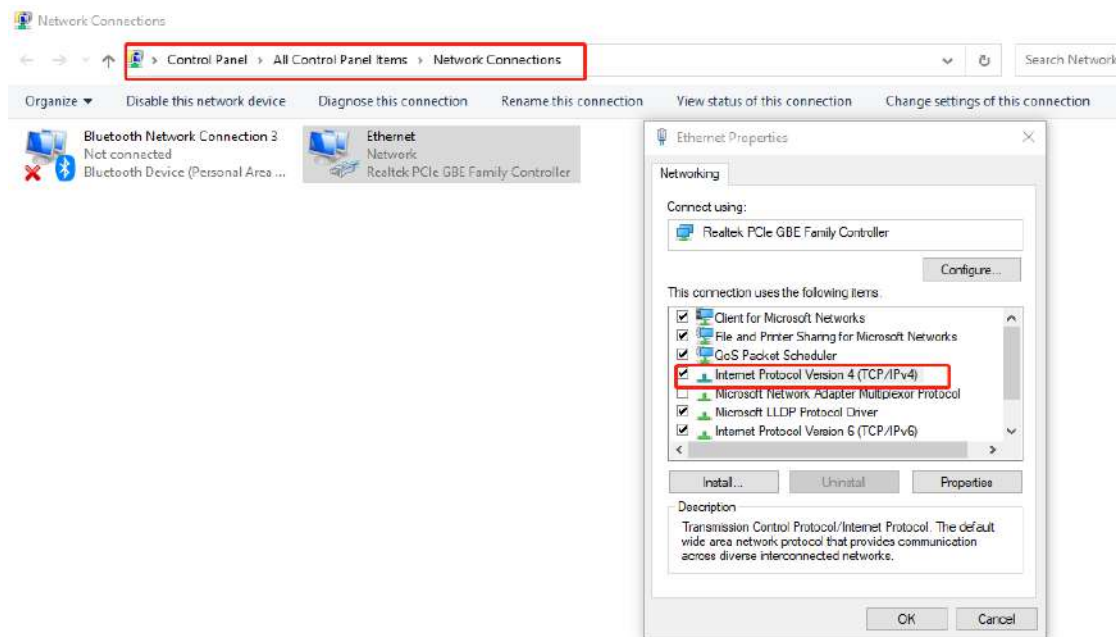

Figure 4.4 Network Connections

Step 3. In the TCP/IPv4 property settings, set the IP address to the lidar's destination IP (The default destination IP of the lidar is 192.168.1.102), and the subnet mask is set to 255.255.255.0.

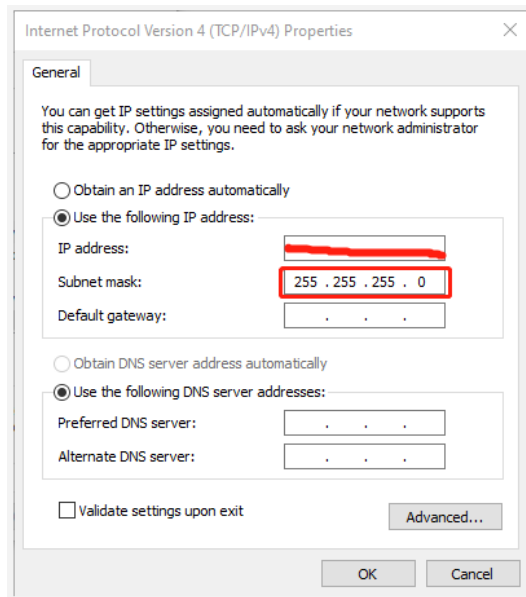

Figure 4.5 IP Address and Subnet Mask Setting

4) Since the LS Windows Client needs to obtain a large number of data packets through the network in a short time, it may be considered as a malicious program by the network firewall and be prohibited. Therefore, there may be situations in which the data packet has been sent to the computer by the Wireshark software, but the client cannot display it.

To address this problem, in Control Panel -> System and Security -> Windows Firewall Settings, click to allow this program to pass through Windows Firewall, setting steps are as shown in the figures below:

Step 1. In Control Panel -> System and Security -> Windows Defender Firewall, click “Allow an app or feature through the Windows Defender Firewall”.

Step 2. Browse to find the software installation path, select it and click OK.

Step 3. Tick the part marked in the red box according to the nature of your network, and click OK to see the data.

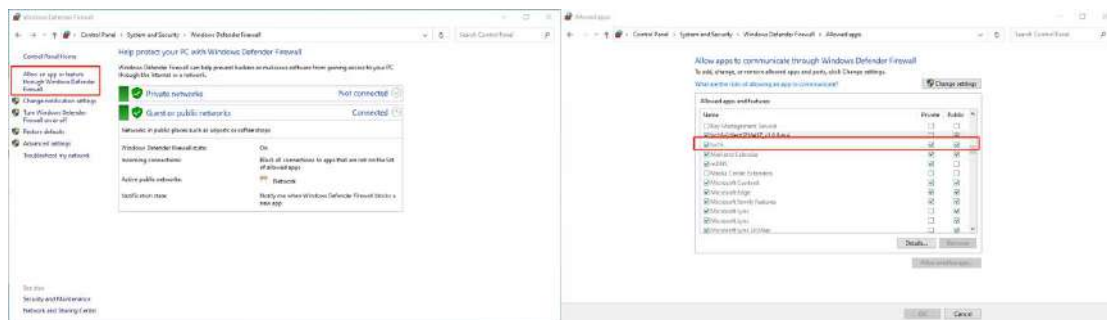

Figure 4.6 Windows Defender Firewall Setting

Computer graphics settings

When installing the LS Windows Client on a desktop or laptop with dual graphics cards, the default global settings of the computer operating system is to use the global settings (automatic selection: integrated graphics), which affects the display efficiency of the software. In order to ensure the use and display efficiency of the software, you need to manually set the computer graphics.

The condition of dual graphics cards can be checked in the computer configuration, and the condition of the display adapter can be seen in My Computer->Properties->Device Manager.

Take a laptop with Intel(R)HD Graphics 530 integrated graphics and NVIDIA GeForce GTX 960 discrete graphics as an example. The setting steps to manually switch the applicable graphics card of the software to high-performance discrete graphics card are as follows:

Step 1. Right-click on a blank space on the desktop to pop up a right-click menu and select "NVIDIA Control Panel".

Step 2. Select the "Manage 3D Settings" in the NVIDIA Control Panel interface.

Step 3. Click the "Program Settings" button in the Manage 3D Settings interface.

Step 4. Click the "Add" button on the Manage 3D Settings interface.

Step 5. Click the "Browse" button in the pop-up interface.

Step 6. Find the application file (.exe file) of the software according to its installation path in the pop-up browsing interface.

Step 7. Click "OK" to automatically return to the NVIDIA control panel, select the high-performance NVIDIA processor in the combo box of the preferred graphics processor for this program in Option -2., and click "Apply" in the lower right corner.

After the computer application is set, close the NVIDIA Control Panel to complete the setting.

4.2 ROS Driver Operation Under Linux OS

4.2.1 Hardware Connection and Test

Step 1. Connect the lidar to the internet and power supply

Step 2. Set the computer wired IP according to the destination IP of the lidar, (whether the computer wired IP is set successfully can be checked by the ifconfig command, as shown in the figure, the destination IP is 192.168.1.102)

```

ls@ls-Inspiron-15-3511:~$ ifconfig
enxf8e43b292f8c: flags=4163<UP,BROADCAST,RUNNING,MULTICAST> mtu 1500
    inet 192.168.1.102 netmask 255.255.255.0 broadcast 192.168.1.255
    inet6 fe80::898a:1bfd:a729:2f4e prefixlen 64 scopeid 0x20<link>
    ether f8:e4:3b:29:2f:8c txqueuelen 1000 (以太网)
    RX packets 254127 bytes 313581906 (313.5 MB)
    RX errors 254118 dropped 3 overruns 0 frame 254118
    TX packets 76 bytes 9406 (9.4 KB)
    TX errors 0 dropped 0 overruns 0 carrier 0 collisions 0

```

Figure 4.7 ifconfig Command Feedback

Note: The default destination IP of the lidar is 192.168.1.102, and the computer must be configured according to the actual lidar destination IP. After setting the IP for the first time, please restart the lidar.

Step 3. After the lidar is powered on and restarted, check the wired connection icon of the computer to see whether it is connected properly.

Step 4. Open the terminal: ping the lidar IP, and test whether the hardware is connected normally. If the ping is successful, then the data is received, otherwise check the hardware connection.

Step 5. Use “sudo tcpdump -n -i eth0” (here eth0 is the name of the wired network device, see the device name of ifconfig wired connection display for details) to view the data packets sent by the lidar (as shown in the figure, there are 1206-byte data packets sent by the lidar to the destination, which means that the lidar data is sent normally).

```

leishen@robot:~$ sudo tcpdump -n -i eth0
tcpdump: verbose output suppressed, use -v or -vv for full protocol decode
listening on eth0, link-type EN10MB (Ethernet), capture size 262144 bytes
19:49:08.973111 IP 192.168.1.200.2368 > 192.168.1.102.2368: UDP, length 1206
19:49:08.973717 IP 192.168.1.200.2368 > 192.168.1.102.2368: UDP, length 1206
19:49:08.974308 IP 192.168.1.200.2368 > 192.168.1.102.2368: UDP, length 1206
19:49:08.974913 IP 192.168.1.200.2368 > 192.168.1.102.2368: UDP, length 1206
19:49:08.975517 IP 192.168.1.200.2368 > 192.168.1.102.2368: UDP, length 1206
19:49:08.976107 IP 192.168.1.200.2368 > 192.168.1.102.2368: UDP, length 1206
19:49:08.976714 IP 192.168.1.200.2368 > 192.168.1.102.2368: UDP, length 1206

```

Figure 4.8 sudo tcpdump -n -i eth0 Command Feedback

4.2.2 Software Operation Example

Step 1. Establish a workspace and build a compilation environment

```

mkdir -p ~/leishen_ws/src

cd ~/leishen_ws

```

Note: The workspace can be named arbitrarily. For example, “leishen_ws” can be changed to any name.

Step 2. Download the Lidar ROS driver

The ROS driver can also be obtained directly from our website or customer service. Copy the obtained driver file to the newly created workspace “src”, and decompress it.

Step 3. Compile and package

```
cd ~/leishen_ws  
  
catkin_make
```

Step 4. Run the program

```
source devel/setup.bash  
  
roslaunch ls lidar_ms06_driver ls lidar_ms06.launch
```

Reopen a terminal again and execute the following command:

```
roslaunch rviz rviz
```

Note 1): If the lidar destination port and motor speed are modified, please open “ls lidar_ms06.launch” to modify the configuration accordingly. The default data packet port is 2368, device packet port is 2369, IP address is 192.168.1.200.

Note 2): If timeout appears, it means that the driver has no data reception. Please check the hardware connection.

Note 3): If steps 1, 2, and 3 have been completed, next time after the “Displays Window” is reopened, start directly from step 4.

Step 5. Display the data detected by the lidar

In the “Displays Window” that pops up, modify the value of “Fixed Frame” to “laser_link”. Click the “Add” button at the same time, and click “PointCloud2” under “By topic” to add a multi-line point cloud node.

5. Communication Protocol

Lidar data output and configuration use Fast Ethernet UDP/IP communication protocol. There are 3 UDP packet protocols, and the packet length is 1248 bytes (42 bytes Ethernet header and 1206 bytes payload).

The communication protocols of the lidar are:

Main data Stream Output Protocol (MSOP): outputting the distance, angle, intensity and other information measured by the lidar;

Device Information Output Protocol (DIFOP): outputting the current status of lidar and accessory equipment and various configuration information;

User Configuration Write Protocol (UCWP): setting the configuration parameters of the lidar.

Table 5.1 UDP Packet Protocol

Protocol Name	Abbr.	Function	Length	Transmission Interval
Main data Stream Output Protocol	MSOP	Outputting measured data and timestamp	1248 bytes	0.06712 ms
Device Information Output Protocol	DIFOP	Outputting parameter configuration and status information		1 s (for one packet)
User Configuration Write Protocol	UCWP	Inputting user configured device parameters		Not Fixed

5.1 MSOP Protocol

The data package outputs measured data such as the angle value, distance value, intensity value, and timestamp of the point cloud. The data of the package adopts Big-Endian mode.

The data package includes a 42-byte Ethernet header and a 1206-byte payload, with a total length of 1248 bytes.

5.1.1 Format

The lidar supports single echo mode which measures the most recent echo value.

Each MSOP data packet contains 1206 bytes of data. Each packet of data contains 149 points, that is, $149 \times 8 = 1192$ bytes, and the frame tail is 14 bytes (including 2 bytes reserved, 6 bytes of UTC, 4 bytes of Timestamp and 1 byte of datatype and 1 byte of hardware).

See the figure below:

42 bytes header				
Measure point 1				
Measure point 2				
.....				
Measure point 149				
Reserved	UTC Time	Timestamp	Datatype	Hardware

Note: The lidar displays the point cloud image by frame. In the MSOP data package, if the data of the first point is FF AA BB CC DD EE 11 22, then it is the start mark of the point cloud frame (the lidar scans to the far right at this time). The start mark can be anywhere in a packet of data, not necessarily the packet header. This point is not displayed as point cloud data, but is only a judgment mark for the beginning of an image frame.

5.1.2 Data Package Parameter Description

Ethernet Header

The Ethernet header has a total of 42 bytes, as shown in the table below.

Ethernet Header: 42 Bytes				
Name	S/N	Information	Offset	Length (byte)
Ethernet II MAC	0	Destination	0	6
	1	Source	6	6
Ethernet Packet Type	2	Type	12	2
Internet Protocol	3	Version, Header Length, Differentiated Services, Field, Total Length, Identification, Flags, Fragment Offset, Time to Live, Protocol, Header, Checksum, Source IP Address, Destination IP Address	14	20
UDP Port Number	4	Lidar Port (0x0941, represent 2369)	34	2
	5	Computer Port (0x0940, represent 2368)	36	2
UDP Length & Sum Check	6	Length (0x04BE, represent 1214 bytes)	38	2
	7	Sum Check	40	2

Subframe

The subframe is the effective data area of the data packet, which contains a total

of 1192 bytes, including 149 points, that is, $149 \times 8 = 1192$ bytes. Take the first measure point as an example:

Byte 1	Byte 2	Byte 3	Byte 4	Byte 5	Byte 6	Byte 7	Byte 8
Horizontal angle [15:8]	Horizontal angle [7:0]	Vertical angle [15:8]	Vertical angle [7:0]	Distance [23:16]	Distance [15:8]	Distance [7:0]	Strength

Byte 1 and **Byte 2** represent the horizontal angle. The most significant value in the sequence is stored first, at the lowest storage address while the least significant value is stored at the highest storage address. The unit is 0.01° . For example, $0x11AD = 4525$, that is 45.25° .

Byte 3 and **Byte 4** represent the vertical angle. The most significant value in the sequence is stored first, at the lowest storage address while the least significant value is stored at the highest storage address. The unit is 0.0025° . For example, $0x11AD = 4525$, that is 11.3125° .

Byte 5, **Byte 6**, and **Byte 7** represent the distance value, the most significant value in the sequence is stored first, at the lowest storage address while the least significant value is stored at the highest storage address. Unit: 1 mm.

To analyse the distance value, for example: the distance value in the obtained data packet is represented by the hexadecimal number $0x01, 0x18, 0x32$, and the first two bytes are composed of 24-bit unsigned data, that is: $0x011832$, which is converted to decimal distance value: 71730 mm, that is 71.73 m

Byte 8 represents the echo strength, and the value range is 0-255. (Echo strength can reflect the energy reflection characteristics of the measured object in the actual measurement environment. Therefore, the echo strength can be used to distinguish objects with different reflection characteristics.)

Azimuth

The right side of the lidar is defined as the horizontal angle of 90° , the left side as -90° , and the vertical direction as 0° , as shown in the figure below. The range of the lidar’s horizontal direction is -60° to 60° .

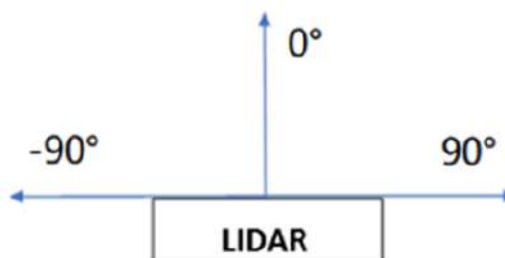

Figure 5.1 The Azimuth of the Lidar

Additional Information

The additional information of the single echo mode is 14 bytes in length, including 2 bytes reserved, 6 bytes of UTC, 4 bytes of Timestamp and 1 byte of datatype and 1 byte of hardware.

The additional information of the dual echo mode is 18 bytes in length, including 6 bytes reserved, 6 bytes of UTC, 4 bytes of Timestamp and 1 byte of datatype and 1 byte of hardware.

Additional Information (single echo mode): 14 bytes			
Name		Length (byte)	Function
Reserved		2	Reserved, by default as 0
UTC		6	Year/month/day/hour/minute/second
Timestamp		4	Timestamp (μ s)
Factory	Vendor Information	1	Lidar model
	Echo Information	1	0x1 represents single echo lidar 0x2 represents dual echo lidar

Additional Information (dual echo mode): 18 bytes			
Name		Length (byte)	Function
Reserved		6	Reserved, by default as 0
UTC		6	Year/month/day/hour/minute/second
Timestamp		4	Timestamp (μ s)
Factory	Vendor Information	1	Lidar model
	Echo Information	1	0x1 represents single echo lidar 0x2 represents dual echo lidar

1) When there is a GPS device inputting PPS signal to the lidar, the timestamp is generated according to the PPS time as the cycle time, and the range of the timestamp is 0-999,999 (μ s);

2) When there is an external synchronization device inputting PPS signal, the timestamp is generated according to the external synchronization PPS time as the cycle time, and the range of the timestamp is 0-999,999 (μ s);

3) When there is no synchronization device inputting PPS signal, the lidar generates timestamp with a period of 1 hour. The range of the timestamp is 0-3,599,999,999 (μ s).

5.2 DIFOP Protocol

The device package outputs read-only parameters and status information such as version number, Ethernet configuration, motor speed and operating status, and fault diagnosis. The data of the device package adopts Big-Endian mode.

The device package includes a 42-byte Ethernet header and a 1206-byte payload, with a length of 1248 bytes. The payload is composed of an 8-byte frame header, 1196-byte data and a 2-byte frame tail.

Header is the device packet identification header, which is fixed as 0xA5,0xFF,0x00,0x5A,0x11,0x11,0x55,0x55, and the first 4 bytes can be used as the packet inspection sequence. The tail is fixed as 0x0F,0xF0.

Figure 5.2 Data Format of the Device Package

Ethernet Header: 42 bytes				
Name	S/N	Information	Offset	Length (byte)
Ethernet II MAC	0	Destination	0	6
	1	Source	6	6
Ethernet Packet Type	2	Type	12	2
Internet Protocol	3	Version, Header Length, Differentiated Services, Field, Total Length, Identification, Flags, Fragment Offset, Time to Live, Protocol, Header, Checksum, Source IP Address, Destination IP Address	14	20
UDP Port Number	4	Lidar Port (0x0940, represents 2368)	34	2
	5	Computer Port (0x0941, represents 2369)	36	2
UDP Length & Sum Check	6	Length (0x04BE, represents 1214 bytes)	38	2
	7	Sum Check	40	2
Payload: 1206 Bytes				
Name	S/N	Information	Offset	Length (byte)
Header	0	DIFOP Identification Header	0	8
Data	1	Reserved	8	2
	2	Ethernet (IP, MAC Port, NTP)	10	22
	3	Ethernet (Gateway, Subnet Mask)	32	8
	4	Reserved	40	2
	5	Device Flow Packet Interval	42	2
	6	Reserved	44	8
	7	UTC	52	6
	8	Latitude and Longitude	58	22
	9	APD Board 1 Temperature	80	2
	10	APD Board 2 Temperature	82	2
	11	APD Board 1/2 High Voltage	84	2
	12	Reserved	86	2
	13	Reserved	88	2
	14	APD Board 3/4 High Voltage	90	2
	15	GPS Status	92	1
	16	PPS Status	93	1
	17	Fast Axis Motor Speed	94	4
	18	Reserved	98	2
	19	Lidar Status Control	100	1
	20	Laser Power Control	101	1
	21	Reserved	102	2
	22	Reserved	104	2
	23	Seed Status	106	2

	24	Laser Status Detection	108	2
	25	Laser Temperature 1	110	2
	26	Laser Temperature 2	112	2
	27	Reserved	114	2
	28	Reserved	116	2
	29	Reserved	118	2
	30	Reserved	120	40
	31	Reserved	160	1044
Tail	32	Tail	1204	2

5.3 UCWP Protocol

The UCWP configures the lidar's Ethernet, motor speed and other parameters, and the data of the configuration package adopts the Big-Endian mode.

The configuration packet includes a 42-byte Ethernet header and a 1206-byte payload, with a length of 1248 bytes. The payload is composed of an 8-byte Header, 1196-byte Data, and a 2-byte Tail.

Header is the configuration packet identification header, which is fixed as 0xAA,0x00,0xFF,0x11,0x22,0x22,0xAA,0xAA, and the first 4 bytes can be used as the packet inspection sequence. The tail is fixed as 0x0F,0xF0.

Note: It is recommended to configure the lidar through the Windows Client. Please do not package and configure the lidar parameters by yourself.

Figure 5.3 Data Format of the Configuration Package

Ethernet Header: 42 bytes				
Name	S/N	Information	Offset	Length (byte)
Ethernet II MAC	0	Destination	0	6
	1	Source	6	6
Ethernet Packet Type	2	Type	12	2
Internet Protocol	3	Version, Header Length, Differentiated Services, Field, Total Length, Identification, Flags, Fragment Offset, Time to Live, Protocol, Header, Checksum, Source IP Address, Destination IP Address	14	20
UDP Port Number	4	Lidar Port (0x0941, represent 2369)	34	2
	5	Computer Port (0x0940, represent 2368)	36	2
UDP Length & Sum Check	6	Length (0x04BE, represent 1214 bytes)	38	2
	7	Sum Check	40	2
Payload: 1206 Bytes				
Name	S/N	Information	Offset	Length (byte)
Header	0	UCWP Identification Header	0	8

Data	1	Reserved	8	2
	2	Ethernet (IP, MAC, Port, NTP)	10	22
	3	Ethernet (Gateway, Subnet Mask)	32	8
	4	Reserved	40	2
	5	Device Flow Packet Interval	42	2
	6	Reserved	44	8
	7	UTC	52	6
	8	Reserved	58	22
	9	Reserved	80	2
	10	Reserved	82	2
	11	Reserved	84	2
	12	Reserved	86	2
	13	Reserved	88	2
	14	Reserved	90	2
	15	Reserved	92	1
	16	Reserved	93	1
	17	Reserved	94	4
	18	Reserved	98	2
	19	Lidar Status Control	100	1
	20	Laser Power Control	101	1
	21	Reserved	102	2
	22	Reserved	104	2
	23	Reserved	106	2
	24	Reserved	108	2
	25	Reserved	110	2
	26	Reserved	112	2
	27	Reserved	114	2
	28	Reserved	116	2
	29	Reserved	118	2
	30	Reserved	120	40
	31	Reserved	160	1044
Tail	32	Tail	1204	2

5.3.1 Configuration Parameters and Status Description

Here below are the configuration parameters and status description of specific lidar information.

Ethernet Configuration

The length of the source IP address "IP_SRC" is 4 bytes and the length of the destination IP address "IP_DEST" is also 4 bytes. Each lidar has a fixed MAC address "MAC_ADDR" (6 bytes in length), which cannot be configured by users. Port1 is the UDP data port number and port2 is the UDP device port number.

Ethernet Configuration (22 bytes)									
S/N	Byte1	Byte2	Byte3	Byte4	Byte5	Byte6	Byte7	Byte8	
Function	IP_SRC				IP_DEST				
S/N	Byte9	Byte10	Byte11	Byte12	Byte13	Byte14	Byte15	Byte16	
Function	MAC_ADDR (Read Only)						Data Port: Port1		

S/N	Byte17	Byte18	Byte19	Byte20	Byte21	Byte22	
Function	Device Port: Port2		Reserved				

Device Flow Packet Interval

Device Flow Packet Interval (2 bytes)		
S/N	Byte0	Byte1
Function	0: send 1 device packet every time 4 data packets are sent; other values: 1 device packet per second	

The configuration 0x0000 means to send 1 device packet every time 4 packets are sent, and other values mean 1 device packet per second. The default value is 1 (1 device packet per second).

UTC

The lidar receives GPS signals and parses the \$GPRMC information. The UTC synchronizes with GPS. If there is no GPS timing, UTC is all 0s. The GPS baud rate supported by the lidar is 9600. There are 8 data bits, 1 stop bit and no parity bit.

UTC (6 bytes Read Only)						
S/N	Byte1	Byte2	Byte3	Byte4	Byte5	Byte6
Function	Year	Month	Day	Hour	Minute	Second
	0~255 corresponding to the year 2000~2255	1~12 month	1~31 day	0~23 hour	0~59 min	0~59 sec

Latitude and Longitude

Latitude and Longitude (22 bytes Read Only)								
S/N	Byte1	Byte2	Byte3	Byte4	Byte5	Byte6	Byte7	Byte8
Function	Reserved	Latitude						
S/N	Byte9	Byte10	Byte11	Byte12	Byte13	Byte14	Byte15	Byte16
Function	Longitude							
S/N	Byte17	Byte18	Byte19	Byte20	Byte21	Byte22		
Function					N/S	W/E		

The latitude and longitude are output in the form of ASCII code.

5.3.2 Configuration Package Example

If you want to reset the lidar IP as 192.168.1.105, computer IP as 192.168.1.225, data port number as 6688, device port number as 8899, according to the definition of the UCWP Packet and each register, it can be reconfigured as follows:

Table 5.4 Configuration Package Example

Info	Content	Configuration	Length (byte)
Header		0xAA,0x00,0xFF,0x11,0x22,0x22,0xAA,0xAA	8
Reserved	Reserved	0x0000	2
Lidar IP (IP_SRC)	192.168.1.105	0xC0,0xA8,0x01,0x69	4
Computer IP (IP_DEST)	192.168.1.225	0xC0,0xA8,0x01,0xE1	4
Data Port (port1)	6688	0x1A20	2
Device Port (port2)	8899	0x22C3	2
Reserved	Reserved	0x0000	2
Reserved	Reserved	0x00	1180
Tail		0x0F,0xF0	2

When using this protocol to configure the device, byte-level or section-level addressing and writing are not allowed, and the entire list must be written completely. After the list is written, the corresponding function will be updated and take effect immediately.

6. Time Synchronization

There are three ways to synchronize the lidar and external equipment: GPS synchronization, external PPS synchronization and gPTP synchronization. If there is no external synchronization input, the lidar internally generates timing information. The absolute accurate time of the point cloud data is obtained by adding the 3-byte hour, minute, second information and the 4-byte timestamp (accurate to microseconds) of the data packet and the 3-byte UTC (year, month and day) of the device packet.

6.1 GPS Synchronization

When GPS synchronization is employed, the lidar will start timing in microseconds after receiving the PPS second pulse, and the time value will be output as the timestamp of the data packet. The lidar extracts UTC information from the \$GPRMC of the GPS as the UTC output, in which the year, month and day information is in the device packet and the hour, minute and second information is in the data packet.

The lidar's GPS_REC interface level protocol follows RS422 level standard.

RS422 level pin definition:

Pin GPS_RX receives the standard serial port data of the RS422 level output from GPS module;

Pin GPS_PPS receives the positive pulse signal output by the GPS module, and the level is required to be +2 V~+6 V; -6 V~-2 V.

If you need to use a computer to test whether the RS422 interface of the whole lidar unit functions properly, because the GPS outputs according to the RS422 serial port protocol and the level of the lidar receiver is RS422, you will need to purchase your own RS422 to USB module to connect to your computer.

The GPS equipment is time-synchronized to mark and calculate the precise emission and data measurement time of each laser. The precise time of the lidar point cloud can be matched with the pitch, roll, yaw, latitude, longitude and height of the GPS/inertial measurement system.

The default serial configuration baud rate of the GPS data output received by the lidar is 9600, 8N1. The PPS high pulse width is required to be more than 1 ms.

The standard format of GPRMC information is as follows:

```
$GPRMC,<1>,<2>,<3>,<4>,<5>,<6>,<7>,<8>,<9>,<10>,<11>,<12> *hh
```

Table 6.1 The Standard Format of \$GPRMC Information

S/N	Name	Description/Format
1	UTC	hhmmss (hour/minute/second)
2	Positioning State	A=Effective Positioning, V=Invalid Positioning
3	Latitude	ddmm.mmmm (degree/minute)
4	Latitude Hemisphere	N (Northern Hemisphere) or S (Southern Hemisphere)
5	Longitude	dddmm.mmmm (degree/minute)
6	Longitude Hemisphere	E (East Longitude) or W (West Longitude)
7	Ground Speed	000.0~999.9 knot
8	Ground Direction	000.0~359.9 degree, take true north as the reference datum
9	UTC Date	ddmmyy (day/month/year)
10	Magnetic Declination	000.0~180.0 degree
11	Direction of Magnetic Declination	E (East) or W (West)
12	Mode Indication	Only NMEA0183 version 3.00 outputs, A= autonomic positioning, D= difference, E=estimation, N=invalid data

6.2 External Synchronization

In external synchronization, the lidar receives the PPS signal input by other external devices and times it in microseconds, and the timing value is output as the timestamp of the data packet. At this time, there is no UTC reference. If UTC is required, it must be written in the configuration package, otherwise the UTC output information of the device package is invalid.

The PPS level of the external synchronization signal is 3.3 V ~5 V, and the lidar receives the rising edge trigger, and the PPS high pulse width is required to be more than 1 ms.

6.3 gPTP Synchronization

Generalized Precise Time Protocol (gPTP) is derived from Precise Time Protocol (PTP) and is used to synchronize the time of individual devices within a local area network with high precision.

This series of lidar supports gPTP timing synchronization. Before synchronizing the lidar via gPTP, the time source needs to be set to "PTP" in the lidar's point cloud display software.

The steps are as follows: open the point cloud display software, click on “parameter” to bring up the parameter modification window, change “Source Selection” to “PTP” as shown in the figure below.

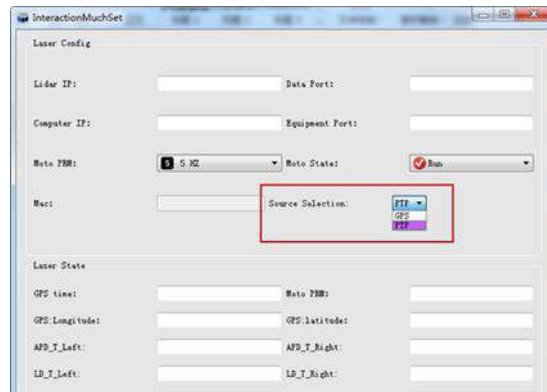

Note:

When “PTP” is selected as the clock source, the lidar no longer outputs GPS packets and the time unit changes to nanoseconds (ns). The Timestamp and Date & Time in the point cloud packets will be synchronized strictly according to the time signal provided by the master clock.

If “PTP” has been selected as the time source and no PTP master clock is currently available, the lidar will start timing from the internal default start time (00:00:00 on 1 January 2000); if a PTP time source is provided and then interrupted, the lidar will continue timing from the time of the interruption.

6.4 Lidar Internal Timing

When there is no GPS and other equipment to synchronize, the lidar uses 1 hour (3,600*10⁶ μs) as the cycle, with microsecond as the timing unit, and the timing value is output as the timestamp of the data packet. At this time, there is no UTC time reference. If UTC time is required, it must be written through the configuration package, otherwise the UTC time output information of the device package will be invalid.

7. Angle and Coordinate Calculation

In order to obtain the vertical angle, horizontal angle and distance parameters of the lidar, the angle and distance information in polar coordinates can be converted to the x, y, z coordinates in the right-hand Cartesian coordinate system. The conversion relationship is shown in the following formula:

$$\begin{cases} x = r \cos \alpha \cos \theta; \\ y = r \cos \alpha \sin \theta; \\ z = r \sin \alpha \end{cases}$$

In the above formula, r is the distance, α is the vertical angle, θ is the horizontal rotation angle (the horizontal correction angle needs to be considered when calculating). And x, y, and z are the coordinates of the polar coordinates projected onto the x, y, and z axes.

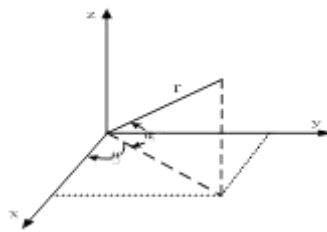

Figure 7.1 Coordinate Mapping

Appendix A. Maintenance

Shipping Requirements

LS series lidars use packaging materials specially customized by our company, which can resist certain vibrations and impacts. For long-distance transportation, special packaging materials must be used to avoid irreversible damage during transportation.

Installation

Use screws that meet the specifications to fix the lidar base, and make sure the base has good heat dissipation. Wear powder-free clean gloves during installation to avoid optical cover contamination and mechanical damage.

Storage Conditions

It is recommended to store the products in a ventilated and dry place where the temperature is $23\pm 5^{\circ}\text{C}$, and the relative humidity is 30% ~ 70%. Do not store in environments where humidity, pH, etc. exceed the protection level.

Dirt Treatment

If the mask is dirty during use, such as with fingerprints, muddy water, dry leaves or insect corpses, etc., the lidar's ranging effect will be directly affected. Please clean it according to the following steps:

Tools: PVC gloves, clean cloth, absolute ethanol (99%)

Environment: ventilated and dry, away from fire

- (1) Put on PVC gloves and fix the lidar base with your fingers; if it is not stubborn stains, use a dust-free cloth or dry air to gently remove the stains;
- (2) For stubborn stains, evenly spray the ethanol in the spray bottle on the location to be cleaned and wait for the stain to be dissolved. Then use a dustless cloth dipped in ethanol solvent, and gently wipe the mask. If the cloth is contaminated, please replace it in time. After cleaning the stain, use a new dustless cloth to remove any remaining liquid.

Appendix B. Troubleshooting

For any of the following problems during the use of the lidar, please refer to the corresponding solutions for troubleshooting. If you are unable to implement the following steps, or if you are still unable to solve the problem after implementing the steps, please contact our technical support.

Problem	Solution
The indicator light on the interface box is not working	Confirm: <ul style="list-style-type: none"> ● power supply meets electrical requirements ● interface box is in good condition with no damage ● power cord contact is good and undamaged; power adapter is working properly ● re-power the lidar to see if the fault disappears
Motor is not running	Confirm: <ul style="list-style-type: none"> ● power supply meets electrical requirements ● good contact between interface box and the lidar ● re-power the lidar to see if the fault disappears
Motor running but no data output on the host PC or Wireshark	Confirm: <ul style="list-style-type: none"> ● power supply meets electrical requirements ● the network cable is well connected ● the IP address of the computer matches the destination IP address of the lidar ● your computer's firewall and other security software that may affect Ethernet broadcasts is turned off ● if the lidar emits laser beam with an IR camera or IR card ● re-power the lidar to see if the fault disappears
Wireshark has data but the host PC has no data	Confirm: <ul style="list-style-type: none"> ● your computer's firewall is turned off ● the IP address of the computer matches the destination IP address of the lidar ● data port and device port in the host computer are set correctly ● lidar port is not occupied by another process ● WinPcap plugin is installed ● re-power the lidar to see if the fault disappears
Point cloud missing	Confirm: <ul style="list-style-type: none"> ● lidar housing is clean and free of stains ● horizontal FOV setting in the host computer ● the number of packets received by the lidar is normal ● whether the lidar emits laser beams, this can be checked with an IR camera or an IR card ● whether there are network conflicts ● whether there is a network blockage caused by other devices transmitting large amounts of data ● connect the PC to the lidar only and observe if the point cloud is missing ● re-power the lidar to see if the fault disappears
Abnormal point cloud image on the host PC (flickering point cloud; irregular point cloud)	Confirm: <ul style="list-style-type: none"> ● the lidar housing is clean and free of stains ● lidar surroundings are not complex ● horizontal FOV setting in the host computer

alignment)	<ul style="list-style-type: none"> ● whether the network is blocked by other devices transmitting data
Error occurs when running the Windows Client, no interface display	Confirm: <ul style="list-style-type: none"> ● the graphics card is used correctly, discrete graphics card is recommended ● the graphics card meets the minimum configuration requirements ● the driver for the graphics card is correctly installed
Crash or no response of the Windows Client when modifying lidar parameters	Confirm: <ul style="list-style-type: none"> ● WinPcap plugin is installed ● the device package port number is correctly filled in ● the computer memory is not full

Revision History

Rev.	Release Date	Revised Content	Issued/Revised By
V1.0.0	2023-05-15	Initial Version	LS1286
V1.0.1	2023-11-07	Specifications modified	LS1499
V1.0.2	2024-04-16	Specifications modified	LS1499

*This product information is subject to change without notice.

Copyright ©2024 LeiShen Intelligent System Co., Ltd. All rights reserved.



**Make Safer Driving
Smarter Machine
and Better Life !**



Official Website: <https://www.lslidar.com>



Sales: sales@lslidar.com

After-Sales: support@lslidar.com